

MAKING MODERN LIVING POSSIBLE

*Danfoss*



## Design Guide

AHF005/010

## Contents

<b>1 How to Read this Design Guide</b>	<b>3</b>
<b>2 Safety and Conformity</b>	<b>4</b>
2.1.2 Abbreviations	4
2.1.3 CE Conformity and Labelling	4
2.1.4 EMC-Directive 2004/108/EG	5
2.1.5 Warnings	5
<b>3 Introduction to Harmonics and Mitigation</b>	<b>7</b>
3.1 What are Harmonics?	7
3.1.1 Linear Loads	7
3.1.2 Non-linear Loads	8
3.1.3 The Effect of Harmonics in a Power Distribution System	9
3.2 Harmonic Limitation Standards and Requirements	9
3.3 Harmonic Mitigation	11
<b>4 Introduction to Advanced Harmonic Filters</b>	<b>12</b>
4.1 Operation Principle	12
4.1.1 Power Factor	13
4.1.2 Capacitor Disconnect	14
<b>5 Selection of Advanced Harmonic Filter</b>	<b>15</b>
5.1 How to Select the Correct AHF	15
5.1.1 Calculation of the Correct Filter Size Needed	15
5.1.2 Calculation Example	15
5.1.3 Voltage Boost	15
5.2 Electrical Data	16
5.2.1 Accessories	26
5.3 General Specification	27
5.3.1 General Technical Data	27
5.3.2 Environmental Data	27
<b>6 How to Install</b>	<b>29</b>
6.1 Mechanical Mounting	29
6.1.1 Safety Requirements of Mechanical Installation	29
6.1.2 Mounting	29
6.1.3 Recommendations for Installation in Industrial Enclosures	29
6.1.4 Ventilation	29
6.2 Electrical Installation	32
6.2.1 Over Temperature Protection	32
6.2.2 Capacitor Disconnect	33

---

6.2.3 Wiring	34
6.2.4 Fuses	36
6.3 Mechanical Dimensions	37
6.3.1 Sketches	37
6.3.2 IP00 Enclosures	47
6.3.3 Physical Dimensions	54
6.3.4 IP00 Dimensions	54
6.3.5 Weight	55
<b>7 How to Programme the Frequency Converter</b>	<b>56</b>
7.1.1 DC-link Compensation Disabling	56
<b>Index</b>	<b>57</b>

# 1 How to Read this Design Guide

This Design Guide will introduce all aspects of the Advanced Harmonic Filters for your VLT® FC Series Drive. It describes Harmonics and how to mitigate them, provide installation instructions and guidance about how to programme the frequency converter.

Danfoss technical literature is also available online at [www.danfoss.com/BusinessAreas/DrivesSolutions/Documentations/Technical+Documentation](http://www.danfoss.com/BusinessAreas/DrivesSolutions/Documentations/Technical+Documentation).

2

## 2 Safety and Conformity

### 2.1.1 Symbols

Symbols used in this manual

#### NOTE

Indicates something to be noted by the reader.



Indicates a general warning.



Indicates a high-voltage warning.

★ Indicates default setting

### 2.1.2 Abbreviations

Active Power	P
Advanced Harmonic Filter	AHF
Alternating current	AC
American wire gauge	AWG
Ampere/AMP	A
Apparent Power	S
Degrees Celsius	°C
Direct current	DC
Displacement Power Factor	DPF
Electro Magnetic Compatibility	EMC
Drive	FC
Gram	g
Harmonic Calculation Software	HCS
Hertz	Hz
Kilohertz	kHz
Local Control Panel	LCP
Meter	m
Millihenry Inductance	mH
Milliampere	mA
Millisecond	ms
Minute	min
Motion Control Tool	MCT
Nanofarad	nF
Newton Meters	Nm
Nominal motor current	$I_{M,N}$
Nominal motor frequency	$f_{M,N}$
Nominal motor power	$P_{M,N}$
Nominal motor voltage	$U_{M,N}$
Parameter	par.
Partial Weighted Harmonic Distortion	PWHD

Point of Common Coupling	PCC
Power Factor	PF
Protective Extra Low Voltage	PELV
Rated Inverter Output Current	$I_{INV}$
Reactive Power	Q
Revolutions Per Minute	RPM
Second	sec.
Short circuit ratio	$R_{SCE}$
Total Demand Distortion	TDD
Total Harmonic Distortion	THD
Total Harmonic Current Distortior	THiD
Total Harmonic Voltage Distortior	THvD
True Power Factor	TPF
Volts	V
$I_{VLT,MAX}$	The maximum output current.
$I_{VLT,N}$	The rated output current supplied by the frequency converter.

Equipment containing electrical components may not be disposed of together with domestic waste. It must be separately collected with electrical and electronic waste according to local and currently valid legislation.

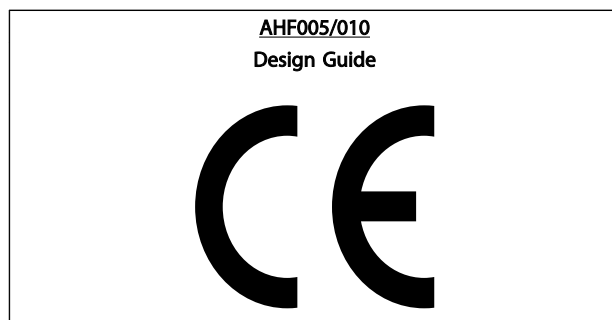

### 2.1.3 CE Conformity and Labelling

#### What is CE Conformity and Labelling?

The purpose of CE labelling is to avoid technical trade obstacles within EFTA and the EU. The EU has introduced the CE label as a simple way of showing whether a product complies with the relevant EU directives. The CE label says nothing about the specifications or quality of the product.

#### The low-voltage directive (73/23/EEC)

Frequency converters must be CE labelled in accordance with the low-voltage directive of January 1, 1997. The directive applies to all electrical equipment and appliances used in the 50 - 1000V AC and the 75 - 1500V DC voltage ranges. Danfoss CE-labels in accordance with the directive and issues a declaration of conformity upon request.

### 2.1.4 EMC-Directive 2004/108/EG

The Danfoss frequency converters comply with the requirements of the EMC -Directive. The AHF are inherently benign equipment, that means that they do not produce electromagnetic disturbances, consisting only of passive components. Therefore, AHF are not within the scope of the EMC-directive. Though, the Danfoss frequency converters in combination with AHF will observe the requirements of the EMC-Directive.

### 2.1.5 Warnings

#### **⚠ WARNING**

Improper installation of the filter or the frequency converter may cause equipment failure, serious injury or death. Follow this Design Guide and install according to National and Local Electrical Codes.

#### **⚠ WARNING**

Never work on a filter in operation. Touching the electrical parts may be fatal - even after the equipment has been disconnected from the drive or motor.

#### **⚠ WARNING**

Before disconnecting the filter, wait at least the voltage discharge time stated in the Design Guide for the corresponding frequency converter to avoid electrical shock hazard.

#### **⚠ CAUTION**

When in use the filter surface temperature rises. DO NOT touch filter during operation.

#### **⚠ CAUTION**

To prevent resonances in the DC-link, it is recommended to disable the dynamic DC-link compensation by setting *14-51 DC Link Compensation* to OFF. See chapter 7 *How to Programme the Frequency Converter*.

#### **⚠ CAUTION**

Temperature contactor must be used to prevent damage of the filter chokes caused by over temperature. An immediate stop or a controlled ramp down within 30 sec. has to be performed to prevent damage of the filter chokes.

#### **NOTE**

Never attempt to repair a defect filter.

#### **NOTE**

The filters represented in this Design Guide are specially designed and tested for operation with Danfoss frequency converters (FC 102/202/301 and 302). Danfoss takes no responsibility for the use of the filters with third party frequency converters.

#### **⚠ WARNING**

Non - authorized removal of required cover, inappropriate use, incorrect installation or operation, creates the risk of severe injury to persons or damage to material assets.

#### **⚠ CAUTION**

All operations concerning transport, installation and commissioning as well as maintenance must be carried out by qualified, skilled personnel (IEC 60364 and CENELEC HD 384 or IEC 60364 and IEC-Report 664 or DIN VDE 0110. National regulations for the prevention of accidents must be observed).

#### **NOTE**

According to this basic safety information qualified skilled personnel are persons who are familiar with the assembly, commissioning and operation of the product and who have the qualifications necessary for their occupation.

#### **NOTE**

The filters are components, that are designed for installation in electrical systems or machinery. When installing in machines, commissioning of the filters (i.e. the starting of operation as directed) is prohibited until it is proven, that the machine corresponds to the regulations of the EC Directive 83/392/EEC (Machinery Directive); EN 60204 must be observed.

#### **NOTE**

Commissioning (i.e. starting operation as directed) is only allowed when there is compliance with the EMC-Directive 89/336/EEC.

The filters meet the requirements of the Low-Voltage Directive 73/23/EEC. The technical data and information on the connection conditions must be obtained from the nameplate and the documentation and must be observed in all cases.

#### **NOTE**

The filter must be protected from inappropriate loads. In particular; during transport and handling: Components are not allowed to be bent. Distance between isolation must not be altered. Touching of electronic components and contacts must be avoided.

**NOTE**

When measuring on live filters, the valid national regulations for the prevention of accidents (e.g. VBG 4) must be observed.

The electrical installation must be carried out according to the appropriate regulations (e.g. cable cross-sections, fuses, PE-connection). When using the filters with frequency converters without safe separation from the supply line (to VDE 0100) all control wiring has to be included in further protective measures (e.g. double insulated or shielded, grounded and insulated).

**NOTE**

Systems where filters are installed, if applicable, have to be equipped with additional monitoring and protective devices according to the valid safety regulations e.g. law on technical tools, regulations for the prevention of accidents, etc.

### 3 Introduction to Harmonics and Mitigation

#### 3.1 What are Harmonics?

##### 3.1.1 Linear Loads

On a sinusoidal AC supply a purely resistive loads (for example an incandescent light bulb) will draw a sinusoidal current, in phase with the supply voltage.

The power dissipated by the load is:

$$P = U \times I$$

For reactive loads (such as an induction motor) the current will no longer be in phase with the voltage, but will lag the voltage creating a lagging true power factor with a value less than 1. In the case of capacitive loads the current is in advance of the voltage, creating a leading true power factor with a value less than 1.

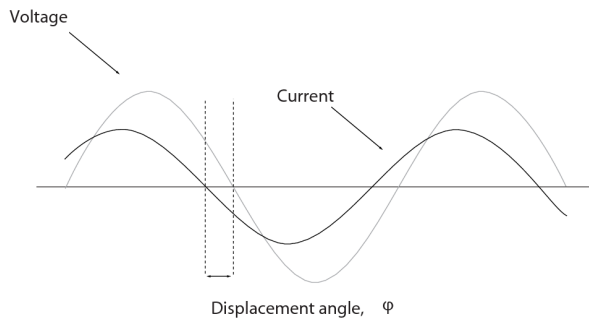

In this case, the AC power has three components: real power (P), reactive power (Q) and apparent power (S). The apparent power is:

$$S = U \times I$$

(where S=[kVA], P=[kW] and Q=[kVAR])

In the case of a perfectly sinusoidal waveform P, Q and S can be expressed as vectors that form a triangle:

$$S^2 = P^2 + Q^2$$

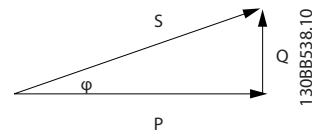

The displacement angle between current and voltage is φ.

The displacement power factor is the ratio between the active power (P) and apparent power (S):

$$DPF = \frac{P}{S} = \cos(\phi)$$



### 3.1.2 Non-linear Loads

Non-linear loads (such as diode rectifiers) draw a non-sinusoidal current. The figure below shows the current drawn by a 6-pulse rectifier on a three phase supply.

3

A non-sinusoidal waveform can be decomposed in a sum of sinusoidal waveforms with periods equal to integer multiples of the fundamental waveform.

$$f(t) = \sum a_h \times \sin(h\omega_1 t)$$

See following illustrations.

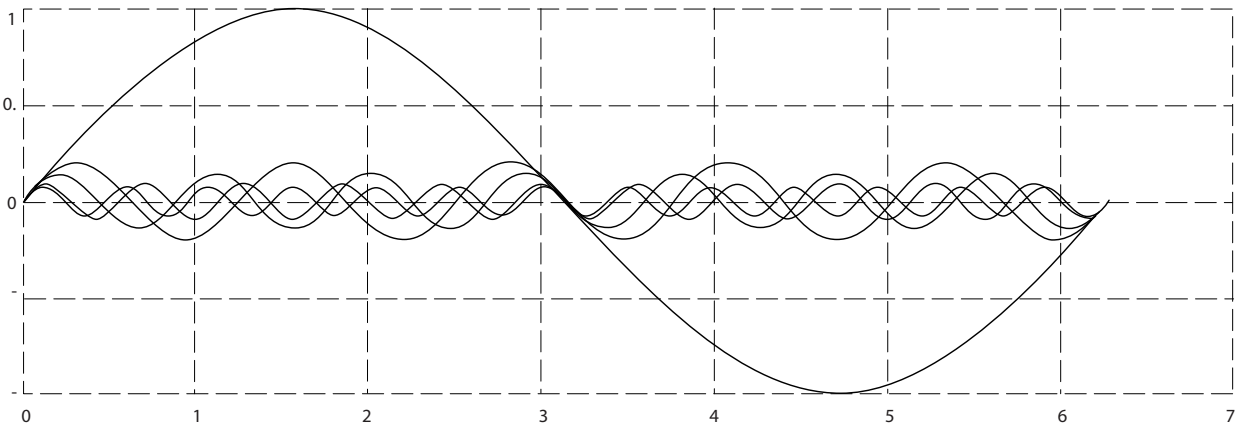

130BB539.10

The integer multiples of the fundamental frequency  $\omega_1$  are called harmonics. The RMS value of a non-sinusoidal waveform (current or voltage) is expressed as:

$$I_{RMS} = \sqrt{\sum_{h=1}^{h_{max}} I_h^2}$$

The amount of harmonics in a waveform gives the distortion factor, or total harmonic distortion (THD), represented by the ratio of RMS of the harmonic content to the RMS value of the fundamental quantity, expressed as a percentage of the fundamental:

$$THD = \sqrt{\sum_{h=2}^{h_{max}} \left(\frac{I_h}{I_1}\right)^2} \times 100\%$$

Using the THD, the relationship between the RMS current  $I_{RMS}$  and the fundamental current  $I_1$  can be expressed as:

$$I_{RMS} = I_1 \times \sqrt{1 + THD^2}$$

The same applies for voltage.

The true power factor PF ( $\lambda$ ) is:

$$PF = \frac{P}{S}$$

In a linear system the true power factor is equal to the displacement power factor:

$$PF = DPF = \cos(\varphi)$$

In non-linear systems the relationship between true power factor and displacement power factor is:

$$PF = \frac{DPF}{\sqrt{1 + THD^2}}$$

The power factor is decreased by reactive power and harmonic loads. Low power factor results in a high RMS current that produces higher losses in the supply cables and transformers.

In the power quality context, the total demand distortion (TDD) term is often encountered. The TDD does not characterize the load, but it is a system parameter. TDD expresses the current harmonic distortion in percentage of the maximum demand current  $I_L$ .

$$TDD = \sqrt{\sum_{h=2}^{h_{max}} \left(\frac{I_h}{I_L}\right)^2} \times 100\%$$

Another term often encountered in literature is the partial weighted harmonic distortion (PWHHD). PWHHD represents a weighted harmonic distortion that contains only the harmonics between the 14th and the 40th, as shown in the following definition.

$$PWHHD = \sqrt{\sum_{h=14}^{40} \left(\frac{I_h}{I_1}\right)^2} \times 100\%$$

### 3.1.3 The Effect of Harmonics in a Power Distribution System

In *Illustration 3.1* a transformer is connected on the primary side to a point of common coupling PCC1, on the medium voltage supply. The transformer has an impedance  $Z_{xfr}$  and feeds a number of loads. The point of common coupling where all loads are connected together is PCC2. Each load is connected through cables that have an impedance  $Z_1$ ,  $Z_2$ ,  $Z_3$ .

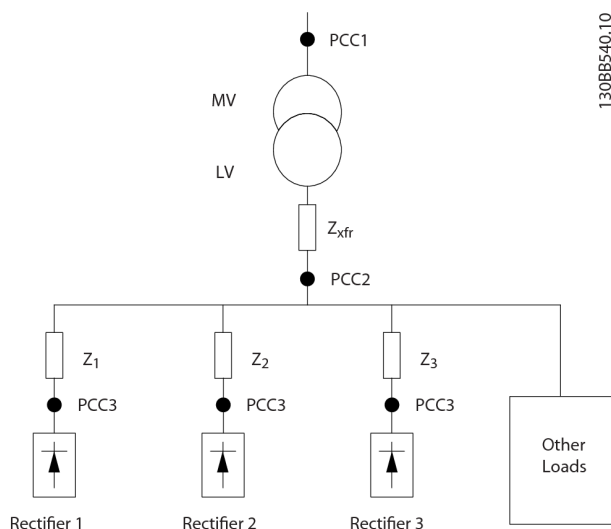

Illustration 3.1 Small Distribution System

Harmonic currents drawn by non-linear loads cause distortion of the voltage because of the voltage drop on the impedances of the distribution system. Higher impedances result in higher levels of voltage distortion.

Current distortion relates to apparatus performance and it relates to the individual load. Voltage distortion relates to system performance. It is not possible to determine the voltage distortion in the PCC knowing only the load's harmonic performance. In order to predict the distortion in the PCC the configuration of the distribution system and relevant impedances must be known.

A commonly used term for describing the impedance of a grid is the short circuit ratio  $R_{sce}$ , defined as the ratio between the short circuit apparent power of the supply at the PCC ( $S_{sc}$ ) and the rated apparent power of the load ( $S_{equ}$ ).

$$R_{sce} = \frac{S_{sc}}{S_{equ}}$$

where  $s_{sc} = \frac{U^2}{Z_{supply}}$  and  $s_{equ} = U \times I_{equ}$

#### The negative effect of harmonics is twofold

- Harmonic currents contribute to system losses (in cabling, transformer)
- Harmonic voltage distortion causes disturbance to other loads and increase losses in other loads

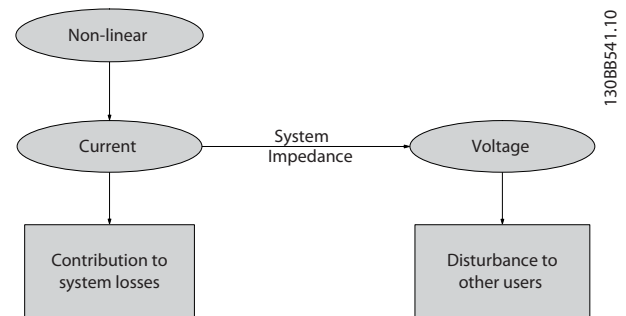

### 3.2 Harmonic Limitation Standards and Requirements

The requirements for harmonic limitation can be:

- Application specific requirements
- Requirements from standards that have to be observed

The application specific requirements are related to a specific installation where there are technical reasons for limiting the harmonics.

For example on a 250kVA transformer with two 110kW motors connected. One is connected direct on-line and the other one is supplied through a frequency converter. If the

direct on-line motor should also be supplied through a frequency converter the transformer will, in this case, be undersized. In order to retrofit, without changing the transformer, the harmonic distortion from the two frequency converter has to be mitigated using AHF filters.

There are various harmonic mitigation standards, regulations and recommendations. Different standards apply in different geographical areas and industries. The following encountered standards will be presented:

- IEC/EN 61000-3-2
- IEC/EN 61000-3-12
- IEC/EN 61000-3-4
- IEC 61000-2-2
- IEC 61000-2-4
- IEEE 519
- G5/4

#### **IEC 61000-3-2, Limits for harmonic current emissions (equipment input current $\leq 16A$ per phase)**

The scope of IEC 61000-3-2 is equipment connected to the public low-voltage distribution system having an input current up to and including 16 A per phase. Four emission classes are defined: Class A through D. The Danfoss frequency converters are in Class A. However, there are no limits for professional equipment with a total rated power greater than 1kW.

#### **IEC 61000-3-12, Limits for harmonic currents produced by equipment connected to public low-voltage systems with input current $>16A$ and $\leq 75A$**

The scope of IEC 61000-3-12 is equipment connected to the public low-voltage distribution system having an input current between 16A and 75A. The emission limits are currently only for 230/400V 50Hz systems and limits for other systems will be added in the future. The emission limits that apply for drives are given in Table 4 in the standard. There are requirements for individual harmonics (5th, 7th, 11th, and 13th) and for THD and PWHD. Frequency converters from the Automation Drive series (FC 102 HVAC, FC 202 Aqua and FC 302 Industry) comply with these limits without additional filtering.

#### **IEC 61000-3-4, Limits, Limitation of emission of harmonic currents in low-voltage power supply systems for equipment with rated current greater than 16A**

IEC 61000-3-12 supersedes IEC 61000-3-4 for currents up to 75A. Therefore the scope of IEC 61000-3-4 is equipment with rated current greater than 75A connected to the public low-voltage distribution system. It has the status of *Technical report* and should not be seen as an international standard. A three-stage assessment procedure is described for the connection of equipment to the public supply and equipment above 75A is limited to stage 3 *connection based on the load's agreed power*. The supply authority may accept the connection of the equipment on the basis of the agreed

active power of the load's installation and local requirements of the power supply authority apply. The manufacturer shall provide individual harmonics and the values for THD and PWHD.

#### **IEC 61000-2-2 and IEC 61000-2-4 Compatibility levels for low-frequency conducted disturbances**

IEC 61000-2-2 and IEC 61000-2-4 are standards that stipulate compatibility levels for low-frequency conducted disturbances in public low-voltage supply systems (IEC 61000-2-2) and industrial plants (IEC 61000-2-4). These low-frequency disturbances include but are not limited to harmonics. The values prescribed in these standards shall be taken into consideration when planning installations. In some situations the harmonic compatibility levels can not be observed in installations with frequency converters and harmonic mitigation is needed.

#### **IEEE519, IEEE recommended practices and requirements for harmonic control in electrical power systems**

IEEE519 establishes goals for the design of electrical systems that include both linear and nonlinear loads. Waveform distortion goals are established and the interface between sources and loads is described as point of common coupling (PCC).

IEEE519 is a system standard that aims the control of the voltage distortion at the PCC to a THD of 5% and limits the maximum individual frequency voltage harmonic to 3%. The development of harmonic current limits aims the limitation of harmonic injection from individual customers so they will not cause unacceptable voltage distortion levels and the limitation of the overall harmonic distortion of the system voltage supplied by the utility.

The current distortion limits are given in Table 10.3 in the standard and depend on the ratio  $I_{sc}/I_L$  where  $I_{sc}$  is the short circuit current at the utility PCC and  $I_L$  is the maximum demand load current. The limits are given for individual harmonics up to the 35th and total demand distortion (TDD). Please note that these limits apply at the PCC to the utility. While requiring individual loads to comply with these limits also ensures the compliance at the PCC, this is rarely the most economic solution, being unnecessarily expensive. The most effective way to meet the harmonic distortion requirements is to mitigate at the individual loads and measure at the PCC.

However, if in a specific application it is required that the individual drive should comply with the IEEE519 current distortion limits, an AHF can be employed to meet these limits.

#### **G5/4, Engineering recommendation, planning levels for harmonic voltage distortion and the connection of non-linear equipment to transmission systems and distribution networks in the United Kingdom**

G5/4 sets planning levels for harmonic voltage distortion to be used in the process of connecting non-linear equipment. A process for establishing individual customer emission

limits based on these planning levels is described. G5/4 is a system level standard.

For 400V the voltage THD planning level is 5% at the PCC. Limits for odd and even harmonics in 400V systems are given in Table 2 in the standard. An assessment procedure for the connection of non-linear equipment is described. The procedure follows three stages, aiming to balance the level of detail required by the assessment process with the degree of risk that the connection of particular equipment will result in unacceptable voltage harmonic distortion.

Compliance of a system containing VLT® frequency converters depends on the specific topology and population of non-linear loads. AHF can be employed to meet the requirements of G5/4.

### 3.3 Harmonic Mitigation

To mitigate the harmonics caused by the frequency converter 6-pulse rectifier several solutions exist and they all have their advantages and disadvantages. The choice of the right solution depends on several factors:

- The grid (background distortion, mains unbalance, resonance and type of supply - transformer/generator)
- Application (load profile, number of loads and load size)
- Local/national requirements/regulations (IEEE519, IEC, G5/4, etc.)
- Total cost of ownership (initial cost, efficiency, maintenance, etc.)

IEC standards are harmonized by various countries or supra-national organizations. All above mentioned IEC standards are harmonized in the European Union with the prefix "EN". For example the European EN 61000-3-2 is the same as IEC 61000-3-2. The situation is similar in Australia and New Zealand, with the prefixes AS/NZS.

Harmonic solutions can be divided into two main categories: passive and active. Where the passive solutions consist of capacitors, inductors or a combination of the two in different arrangements.

The simplest solution is to add inductors/reactors of typically 3% to 5% in front of the frequency converter. This added inductance reduces the amount of harmonic currents produced by the drive. More advanced passive solutions combine capacitors and inductors in trap arrangement specially tuned to eliminate harmonics starting from e.g. the 5<sup>th</sup> harmonic.

The active solutions determine the exact current that would cancel the harmonics present in the circuit and synthesizes and injects that current into the system. Thus the active solution can mitigate the real-time harmonic disturbances, which makes these solutions very effective at any load profile. To read more about the Danfoss active solutions Low Harmonic Drive (LHD) or Active Filters (AAF) please see MG.34.OX.YY and MG.90.VX.YY.

## 4 Introduction to Advanced Harmonic Filters

**4**

### 4.1 Operation Principle

The Danfoss Advanced Harmonic Filters (AHF) consist of a main inductor  $L_0$  and a two-stage absorption circuit with the inductors  $L_1$  and  $L_2$  and the capacitors  $C_1$  and  $C_2$ . The absorption circuit is specially tuned to eliminate harmonics starting with the 5<sup>th</sup> harmonic and is specific for the designed supply frequency. Consequently the circuit for 50Hz has different parameters than the circuit for 60Hz.

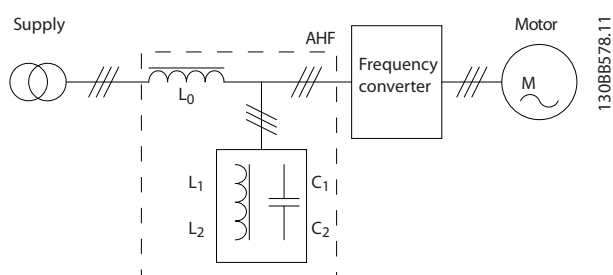

AHFs are available in two variants for two performance levels: AHF005 with 5% THiD (total current harmonic distortion) and AHF010 with 10% THiD. The strategy behind the two levels is to offer a performance similar to 12 pulse rectifiers with the AHF010 and a performance similar to 18 pulse rectifiers with AHF005.

The filter performance in terms of THiD varies as a function of the load. At nominal load the performance of the filter should be equal or better than 10% THiD for AHF010 and 5% THiD for AHF005.

At partial load the THiD has higher values. However, the absolute value of the harmonic current is lower at partial loads, even if the THiD has a higher value. Consequently, the negative effect of the harmonics at partial loads will be lower than at full load.

#### Example:

An 18.5kW frequency converter is installed on a 400V/50Hz grid with a 34A AHF010 (type code AHF-DA-34-400-50-20-A). Following values are measured for different load currents, using a harmonic analyzer:

I line RMS [A]	Fundamental current at 50Hz I <sup>1</sup> RMS [A]	THiD [%]	Total harmonic current I <sub>h</sub> RMS [A] <sup>1)</sup>
9.6	9.59	5.45	0.52
15.24	15.09	13.78	2.07
20.24	20.08	12.46	2.5
25.17	25	11.56	2.89
30.27	30.1	10.5	3.15
34.2	34.03	9.95	3.39

<sup>1)</sup>The total harmonic current has been calculated. The THiD vs. load plot is shown in the following figure.

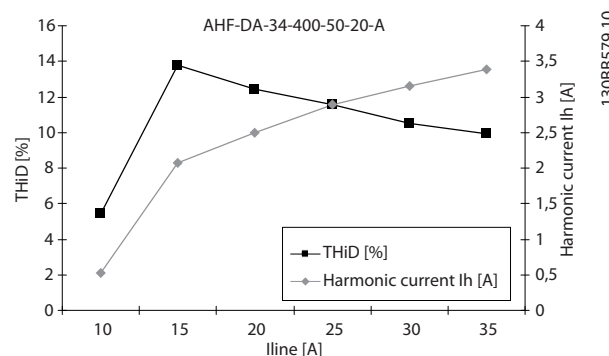

It can be observed that at partial load, 15A, the THiD is approximately 14%, compared to 10% at the nominal load of 34A. On the other hand, the total harmonic current is only 2.07A at 15A line current against 3.39A harmonic current at 34A line current. Thus, THiD is only a relative indicator of the harmonic performance. The harmonic distortion of the voltage will be less at partial load than at nominal load.

Factors such as background distortion and grid unbalance can affect the performance of AHF filters. The specific figures are different from filter to filter and the graphs below show typical performance characteristics. For specific details a harmonic design tool such as MCT 31 or Harmonic Calculation Software (HCS) should be used.

**Background distortion:** The design of the filters aims to achieve 10% respectively 5% THiD levels with a background distortion of THvD = 2%. Practical measurements on typical grid conditions in installations with frequency converters show that often the performance of the filter is slightly better with a 2% background distortion. However, the complexity of the grid conditions and mix of specific harmonics can not allow a general rule about the performance on a distorted grid. Therefore we have chosen to present worst-case performance deterioration characteristics with the background distortion.

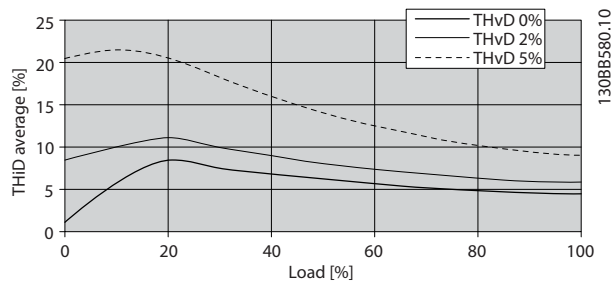

Illustration 4.1 AHF005

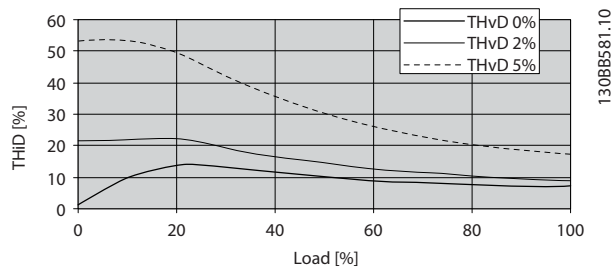

Illustration 4.2 AHF010

Performance at 10% THvD has not been plotted. However, the filters have been tested and can operate at 10% THvD but the filter performance can no longer be guaranteed.

The filter performance also deteriorates with the unbalance of the supply. Typical performance is shown in the graphs below.

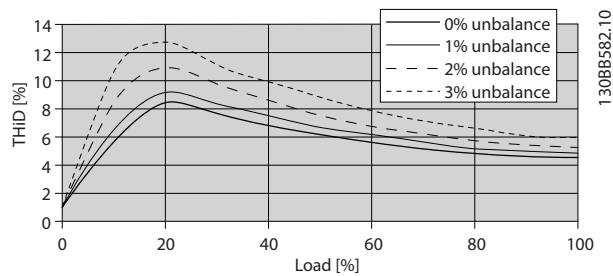

Illustration 4.3 AHF005

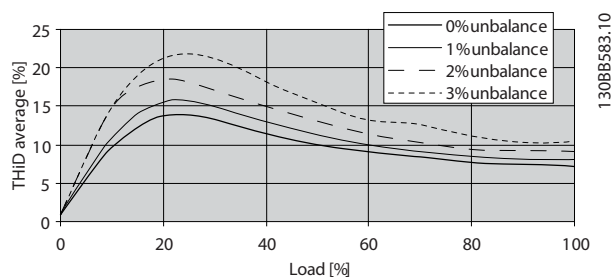

Illustration 4.4 AHF010

### 4.1.1 Power Factor

In no load conditions (the frequency converter is in stand-by) the frequency converter current is negligible and the main current drawn from the grid is the current through the capacitors in the harmonic filter. Therefore the power factor is close to 0, capacitive. The capacitive current is approximately 25% of the filter nominal current (depends on filter size, typical values between 20 and 25%). The power factor increases with the load. Because of the higher value of the main inductor  $L_0$  in the AHF005, the power factor is slightly higher than in the AHF010.

Following graphs show typical values for the true power factor on AHF010 and AHF005.

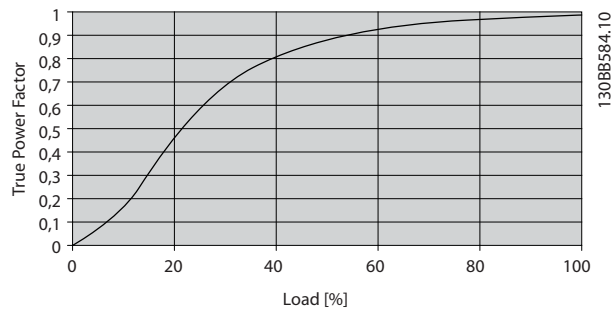

Illustration 4.5 AHF005

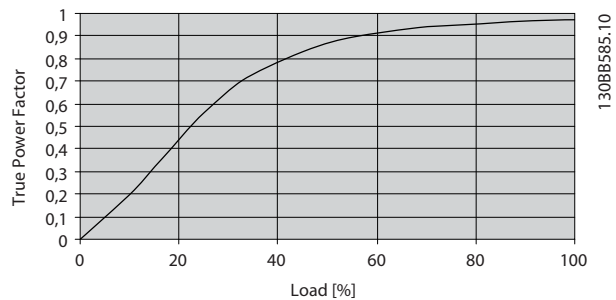

Illustration 4.6 AHF010

### 4.1.2 Capacitor Disconnect

If the specific application requires a higher power factor at no-load and the reduction of the capacitive current in stand-by, a capacitor disconnect should be used. A contactor can disconnect the capacitor at loads below 20%. It is important to note that the capacitors may not be connected at full load or disconnected at no load.

It is very important to consider the capacitive current in the design of applications where the harmonic filter is supplied by a generator. The capacitive current can overexcite the generator in no-load and low-load condition. The over-excitation causes an increase of the voltage that can exceed the allowed voltage for the AHF and the frequency converter. Therefore a capacitor disconnect should always be used in generator applications and the design carefully considered.

Compared to multi-pulse rectifiers, passive harmonic filter (such as AHF) are more robust against background distortion and supply imbalance. However, the performance of passive filters is inferior to the performance of active filters when it comes to partial load performance and power factor. For details about the performance positioning of the various harmonic mitigation solutions offered by Danfoss, please consult the relevant harmonic mitigation literature.

## 5 Selection of Advanced Harmonic Filter

This chapter will provide guidance about how to choose the right filter size and contains calculation examples, electrical data and the general specification of the filters.

### 5.1 How to Select the Correct AHF

For optimal performance the AHF should be sized for the mains input current to the frequency converter. This is the input current drawn based on the expected load of the frequency converter and not the size of the frequency converter itself.

#### 5.1.1 Calculation of the Correct Filter Size Needed

The mains input current of the frequency converter ( $I_{FC,L}$ ) can be calculated using the nominal motor current ( $I_{M,N}$ ) and the displacement factor ( $\cos \varphi$ ) of the motor. Both values are normally printed on the name plate of the motor. In case the nominal motor voltage ( $U_{M,N}$ ) is unequal to the actual mains voltage ( $U_L$ ), the calculated current must be corrected with the ratio between these voltages as shown in the following equation:  $I_{FC,L} = 1.1 \times I_{M,N} \times \cos(\varphi) \times \frac{U_{M,N}}{U_L}$

The AHF chosen must have a nominal current ( $I_{AHF,N}$ ) equal to or larger than the calculated frequency converter mains input current ( $I_{FC,L}$ ).

#### NOTE

**Do not oversize the AHF. The best harmonic performance is obtained at nominal filter load. Using an oversized filter will most likely result in reduced THiD performance.**

If several frequency converters are to be connected to the same filter, the AHF must be sized according to the sum of the calculated mains input currents.

#### NOTE

**If the AHF is sized for a specific load and the motor is changed, the current must be recalculated to avoid overloading the AHF.**

### 5.1.2 Calculation Example

System mains voltage ( $U_L$ ):	380V
Motor name plate power ( $P_M$ ):	55kW
Motor efficiency ( $\eta_M$ ):	0.96
FC efficiency ( $\eta_{FC}$ ):	0.97
AHF efficiency ( $\eta_{AHF}$ )(worst case estimate):	0.98

Maximum line current (RMS):

$$\frac{P_M \times 1000}{U_L \times \eta_M \times \eta_{FC} \times \eta_{AHF} \times \sqrt{3}} = \frac{55 \times 1000}{380 \times 0.96 \times 0.97 \times 0.98 \times \sqrt{3}} = 91.57 \text{ A}$$

In this case a 96A filter must be chosen.

### 5.1.3 Voltage Boost

In stand-by and under low condition, the AHFs will boost the input voltage with up to 5%. This means that the voltage at the frequency converter terminals is up to 5% higher than the voltage at the input of the filter. This should be considered at the design of the installation. Special care should be taken in 690V applications, where the voltage tolerance of the frequency converter is reduced to +5%, the boost voltage can, at low load and stand-by, be limited via the available capacitor disconnect. For more information see section 6.2.2.



## 5.2 Electrical Data

Code number	Code number	Filter current rating	Typical motor		VLT power and current ratings		Losses		Acoustic noise		Frame size	
			A	kW	kW	A	AHF005 W	AHF010 W	dBa	AHF005	AHF010	
AHF005	AHF010											
IP00	IP00											
IP20	IP20											
130B1392	130B1262	10	3	PK37-P4K0	1.2-9	131	93	<70	X1	X1		
130B1229	130B1027	14	7.5	P5K5-P7K5	14.4	184	118	<70	X1	X1		
130B1393	130B1263	22	11	P11K	22	258	206	<70	X2	X2		
130B1231	130B1058	29	15	P15K	29	298	224	<70	X2	X2		
130B1394	130B1268	34	18.5	P18K	34	335	233	<72	X3	X3		
130B1232	130B1059	40	22	P22K	40	396	242	<72	X3	X3		
130B1395	130B1270	55	30	P30K	55	482	274	<72	X3	X3		
130B1233	130B1089	66	37	P37K	66	574	352	<72	X4	X4		
130B1396	130B1273	82	45	P45K	82	688	374	<72	X4	X4		
130B1238	130B1094	96	55	P55K	96	747	428	<75	X5	X5		
130B1397	130B1274	133	75	P75K	133	841	488	<75	X5	X5		
130B1239	130B1111	171	90	P90K	171	962	692	<75	X6	X6		
130B1398	130B1275	204	110	P110	204	1080	742	<75	X6	X6		
130B1240	130B1176	251	132	P132	251	1195	864	<75	X7	X7		
130B1399	130B1281	304	160	P160	304	1288	905	<75	X7	X7		
130B1241	130B1180	325	Paralleling for 355kW			1406	952	<75	X8	X8		
130B1442	130B1291	381	200	P200	381	1510	1175	<77	X8	X8		
130B1247	130B1201	480	250	P250	472	1852	1542	<77	X8	X8		
130B1443	130B1292											
130B1248	130B1204											
130B1444	130B1293											
130B1249	130B1207											
130B1445	130B1294											
130B1250	130B1213											
130B1446	130B1295											
130B1251	130B1214											
130B1447	130B1369											
130B1258	130B1215											
130B1448	130B1370											
130B1259	130B1216											
130B3153	130B3151											
130B3152	130B3136											
130B1449	130B1389											
130B1260	130B1217											
130B1469	130B1391											
130B1261	130B1228											

Table 5.1 380-415V, 50Hz

Code number	Code number	Filter current rating	Typical motor kW	VLT power and current ratings		Losses		Acoustic noise		Frame size
				A	kW	AHF005 W	AHF010 W	dB(A)	dB(A)	
AHF005	AHF010									
IP00	IP00									
IP20	IP20									
2 x 130B1448	2 x 130B1370	608	315	P315	590	2576	1810	<80		
2 x 130B1259	2 x 130B1216									
2 x 130B3153	2 x 130B3151	650	355	P355	647	2812	1904	<80		
2 x 130B3152	2 x 130B3136									
130B1448 + 130B1449	130B1370 + 130B1389	685	400	P400	684	2798	2080	<80		
130B1259 + 130B1260	130B1216 + 130B1217									
2 x 130B1449	2 x 130B1389	762	450	P450	779	3020	2350	<80		
2 x 130B1260	2 x 130B1217									
130B1449 + 130B1469	130B1389 + 130B1391	861	500	P500	857	3362	2717	<80		
130B1260 + 130B1261	130B1217 + 130B1228									
2 x 130B1469	2 x 130B1391	960	560	P560	964	3704	3084	<80		
2 x 130B1261	2 x 130B1228									
3 x 130B1449	3 x 130B1389	1140	630	P630	1090	4530	3525	<80		
3 x 130B1260	3 x 130B1217									
2 x 130B1449 + 130B1469	2 x 130B1389 + 130B1391	1240	710	P710	1227	4872	3892	<80		
2 x 130B1260 + 130B1261	2 x 130B1217 + 130B1228									
3 x 130B1469	3 x 130B1391	1440	800	P800	1422	5556	4626	<80		
3 x 1301261	3 x 130B1228									
2 x 130B1449 + 2 x 130B1469	2 x 130B1389 + 2 x 130B1391	1720	1000	P1000	1675	6724	5434	<80		
2 x 130B1260 + 2 x 130B1261	2 x 130B1217 + 2 x 130B1228									

Table 5.2 380-415V, 50Hz

Code number	Codenummer AHF010		Filter current rating	Typical motor		VLT power and current ratings		Losses		Acoustic noise		Frame size	
	IP00	IP20		A	kW	kW	A	AHF005	AHF010	W	W	dBa	AHF005
130B3095	130B2874		10	3	PK37-P4K0	1.2-9		131	93		<70	X1	X1
130B1257	130B2262		14	7.5	P5K5-P7K5	14.14		184	118		<70	X1	X1
130B3096	130B2875		22	11	P11K	22		258	206		<70	X2	X2
130B2858	130B2265		29	15	P15K	29		298	224		<70	X2	X2
130B3097	130B2876		34	18.5	P18K	34		335	233		<72	X3	X3
130B2859	130B2268		40	22	P22K	40		396	242		<72	X3	X3
130B3098	130B2877		55	30	P30K	55		482	274		<72	X3	X3
130B2860	130B2294		66	37	P37K	66		574	352		<72	X4	X4
130B3099	130B3000		82	45	P45K	82		688	374		<72	X4	X4
130B2861	130B2297		96	55	P55K	96		747	427		<75	X5	X5
130B3124	130B3083		133	75	P75K	133		841	488		<75	X5	X5
130B2862	130B2303		171	90	P90K	171		962	692		<75	X6	X6
130B3125	130B3084		204	110	P110	204		1080	743		<75	X6	X6
130B2863	130B2445		251	132	P132	251		1194	864		<75	X7	X7
130B3026	130B3085		304	160	P160	304		1288	905		<75	X7	X7
130B2864	130B2459		325	Paralleling for 355kW				1406	952		<75	X8	X7
130B3127	130B3086		381	200	P200	381		1510	1175		<77	X8	X8
130B2865	130B2488		480	250	P250	472		1850	1542		<77	X8	X8
130B3128	130B3087												
130B2866	130B2489												
130B3129	130B3088												
130B2867	130B2498												
130B3130	130B3089												
130B2868	130B2499												
130B3131	130B3090												
130B2869	130B2500												
130B3132	130B3091												
130B2870	130B2700												
130B3133	130B3092												
130B2871	130B2819												
130B3157	130B3155												
130B3156	130B3154												
130B3134	130B3093												
130B2872	130B2855												
130B3135	130B3094												
130B2873	130B2856												

Table 5.3 380-415V, 60Hz

Code number AHF005 IP00 IP20	Codenummer AHF010 IP00 IP20	Filter current		Typical motor		VLT power and current ratings			Losses		Acoustic noise		Frame size
		A	rating	kW	motor	kW	A	W	AHF005	AHF010	dB(A)	W	
2 x 130B3133	2 x 130B3092	608	315	P315	590	2576	1810	<80	AHF005	AHF010	<80	AHF005	AHF010
2 x 130B2871	2 x 130B2819	650	315	P355	647	2812	1904	<80					
2 x 130B3157	2 x 130B3155	685	355	P400	684	2798	2080	<80					
2 x 130B3156	2 x 130B3154	762	400	P450	779	3020	2350	<80					
130B3133 + 130B3134	130B3092 + 130B3093	861	450	P500	857	3362	2717	<80					
130B2871 + 130B2872	130B2819 + 130B2855	960	500	P560	964	3704	3084	<80					
2 x 130B3134	2 x 130B3093	1140	560	P630	1090	4530	3525	<80					
2 x 130B2872	2 x 130B2856	1240	630	P710	1227	4872	3892	<80					
2 x 130B3135	2 x 130B3094	1440	710	P800	1422	5556	4626	<80					
2 x 130B2873	2 x 130B2856	1722	800	P1M0	1675	6724	5434	<80					
2 x 130B3134 + 2 x 130B3135	2 x 130B3093 + 2 x 130B3094												
2 x 130B2872 + 2 x 130B2873	2 x 130B2855 + 2 x 130B2856												

Table 5.4 380-415V, 60Hz

Code number	Codenummer	Filter current		Typical motor		VLT power and current ratings		Losses		Acoustic noise		Frame size	
		A	A	HP	HP	HP	A	AHF005	AHF010	W	W	dBA	AHF005
AHF005	AHF010												
IP00	IP00												
IP20	IP20												
130B1787	130B1770	10	4	PK37-P4K0	1-7.4	131	93					X1	X1
130B1752	130B1482	14	10	P5K5-P7K5	9.9+13	184	188					X1	X1
130B1788	130B1771	19	15	P11K	19	258	206					X2	X2
130B1753	130B1483	25	20	P15K	25	298	224					X2	X2
130B1789	130B1772	31	25	P18K	31	335	233					X3	X3
130B1754	130B1484	36	30	P22K	36	396	242					X3	X3
130B1790	130B1773	48	40	P30K	47	482	374					X3	X3
130B1755	130B1485	60	50	P37K	59	574	352					X4	X4
130B1791	130B1774	73	61	P45K	73	688	374					X4	X4
130B1756	130B1486	95	75	P55K	95	747	428					X5	X5
130B1792	130B1775	118	100	P75K	118	841	488					X5	X5
130B1757	130B1487	154	125	P90K	154	962	692					X6	X6
130B1793	130B1776	183	150	P110	183	1080	743					X6	X6
130B1758	130B1488	231	200	P132	231	1194	864					X7	X7
130B1794	130B1777	291	250	P160	291	1288	905					X7	X7
130B1759	130B1491	355	300	P200	348	1406	952					X8	X8
130B1795	130B1778	380	350	P250	436	1852	1542					X8	X7
130B1760	130B1492	436	350	P250	436	1852	1542					X8	X7
130B1796	130B1779												
130B1761	130B1493												
130B1797	130B1780												
130B1762	130B1494												
130B1798	130B1781												
130B1763	130B1495												
130B1799	130B1782												
130B1764	130B1496												
130B1900	130B1783												
130B1765	130B1497												
130B2200	130B1784												
130B1766	130B1498												
130B2257	130B1785												
130B1768	130B1499												
130B3168	130B3166												
130B3167	130B3165												
130B2259	130B1786												
130B1769	130B1751												

Table 5.5 440-480V, 60Hz

Code number AHF005 IP00/IP20	Code number AHF010 IP00/IP20	Filter current rating A	Typical motor kW	VLT power and current ratings			Losses		Acoustic noise		Frame size
				kW	A	W	AHF005 W	AHF010 W	dBa	AHF010	
130B1900 + 130B2200	130B1783 + 130B1784	522	450	P315	531	2482	1769	<80	AHF005 AHF010		
130B1765 + 130B1766	130B1497 + 130B1498	582	500	P355	580	2576	1810	<80			
2 x 130B2200	2 x 130B1784										
2 x 130B1766	2 x 130B1498										
130B2200 + 130B3166	130B1784 + 130B3166	671	550	P400	667	2798	2080	<80			
130B1766 + 130B3167	130B1498 + 130B3165	710	600	P450	711	2812	1904	<80			
2 x 130B2257	2 x 130B1785										
2 x 130B1768	2 x 130B1499										
2 x 130B3168	2 x 130B3166	760	650	P500	759	3020	2350	<80			
2 x 130B3167	2 x 130B3165										
2 x 130B2259	2 x 130B1786	872	750	P560	867	3704	3084	<80			
2 x 130B1769	2 x 130B1751										
3 x 130B2257	3 x 130B1785	1065	900	P630	1022	4218	2856	<80			
3 x 130B1768	3 x 130B1499										
3 x 130B3168	3 x 130B3166	1140	1000	P710	1129	4530	3525	<80			
3 x 130B3167	3 x 130B3165										
3 x 130B2259	3 x 130B1786	1308	1200	P800	1344	5556	4626	<80			
3 x 130B1769	3 x 130B1751										
2 x 130B2257 + 2 x 130B2259	2 x 130B1785 + 2 x 130B1786	1582	1350	P1M0	1490	6516	5988	<80			
2 x 130B1768 + 2 x 130B1768	2 x 130B1499 + 2 x 130B1751										

Table 5.6 440-480V, 60Hz

Code number	Code number AHF010	Filter current rating 50Hz	Typical motor			VLT Power and Current Ratings			Losses		Acoustic noise		Frame size
			A	Hp	kW	A	W	AHF005	AHF010	W	dBa		
130B5261	130B5229	15	10	P11K	15	298	224	<70	X3	X3			
130B5246	130B5212												
130B5262	130B5230	20	16.4	P15K	19.5	335	233	<70	X3	X3			
130B5247	130B5213												
130B5263	130B5231	24	20	P18K	24	396	242	<70	X3	X3			
130B5248	130B5214												
130B5264	130B5232	29	24	P22K	29	482	274	<70	X4	X4			
130B5249	130B5215												
130B5265	130B5233	36	33	P30K	36	574	352	<70	X4	X4			
130B5250	130B5216												
130B5266	130B5234	50	40	P37K	49	688	374	<70	X5	X5			
130B5251	130B5217												
130B5267	130B5235	58	50	P45K	58	747	428	<70	X5	X5			
130B5252	130B5218												
130B5268	130B5236	77	60	P55K	74	841	488	<72	X6	X6			
130B5253	130B5219												
130B5269	130B5237	87	75	P75K	85	962	692	<72	X6	X6			
130B5254	130B5220												
130B5270	130B5238	109	100	P90K	106	1080	743	<72	X6	X6			
130B5255	130B5221												
130B5271	130B5239	128	125	P110	124	1194	864	<72	X6	X6			
130B5256	130B5222												
130B5272	130B5240	155	150	P132	151	1288	905	<72	X7	X7			
130B5257	130B5223												
130B5273	130B5241	197	200	P160	189	1406	952	<72	X7	X7			
130B5258	130B5224												
130B5274	130B5242	240	250	P200	234	1510	1175	<75	X8	X8			
130B5259	130B5225												
130B5275	130B5243	296	300	P250	286	1852	1288	<75	X8	X8			
130B5260	130B5226												

Table 5.7 600V, 60Hz

Code number	Code number	Filter current rating 50Hz	Typical motor	VLT Power and Current Ratings			Losses		Acoustic noise	Frame size
				HP	KW	A	AHF005	AHF010		
AHF005	AHF010	A								
2 x 130B5273	130B5244	366	350	P315/P355	339/366	2812	1542	<75	AHF005 AHF010	X8
2 x 130B5258	130B5227									
2 x 130B5273	130B5245	395	400	P400	395	2812	1852	<75		X8
2 x 130B5258	130B5228									
2 x 130B5274	2 x 130B5242	480	500	P500	482	3020	2350			
2 x 130B5259	2 x 130B5225									
2 x 130B5275	2 x 130B5243	592	600	P560	549	3704	2576			
2 x 130B5260	2 x 130B5226									
3 x 130B5274	2 x 130B5244	732	650	P630	613	4530	3084			
3 x 130B5259	2 x 130B5227									
3 x 130B5274	2 x 130B5244	732	750	P710	711	4530	3084			
3 x 130B5259	2 x 130B5227									
3 x 130B5275	3 x 130B5243	888	950	P800	828	5556	3864			
3 x 130B5260	3 x 130B5226									
4 x 130B5274	3 x 130B5244	960	1050	P900	920	6040	4626			
4 x 130B5259	3 x 130B5227									
4 x 130B5275	3 x 130B5244	1098	1150	P1M0	1032	7408	4626			
4 x 130B5260	3 x 130B5227									
4 x 130B5244	4 x 130B5244	1580	1350	P1M2	1227		6168			
	4 x 130B5227									

Table 5.8 600V, 60Hz



Code number AHF005 IP00/IP20	Code number AHF010 IP00/IP20	Filter current rating			VLT Power and Current Ratings						Losses				Frame size			
		50Hz A	Typical motor size kW	500-550V kW	Typical motor size		551-690V kW	A	W	A	W	A	W	Acoustic noise dBa	AHF005 W	AHF010 W	AHF005	AHF010
					500-550V kW	551-690V kW												
130B5000	130B5297	15	7,5	P11K	15	15	P15K	16	298	224	X3	<70	X3	X3				
130B5088	130B5280																	
130B5017	130B5298	20	11	P15K	19,5	18,5	P18K	20	335	233	X3	<70	X3	X3				
130B5089	130B5281																	
130B5018	130B5299	24	15	P18K	24	22	P22K	25	396	242	X3	<70	X3	X3				
130B5090	130B5282																	
130B5019	130B5302	29	18,5	P22K	29	30	P30K	31	482	274	X4	<70	X4	X4				
130B5092	130B5283																	
130B5021	130B5404	36	22	P30K	36	37	P37K	38	574	352	X4	<70	X4	X4				
130B5125	130B5284																	
130B5022	130B5310	50	30	P37K	49	45	P45K	48	688	374	X5	<70	X5	X5				
130B5144	130B5285																	
130B5023	130B5324	58	37	P45K	59	55	P55K	57	747	428	X5	<70	X5	X5				
130B5168	130B5286																	
130B5024	130B5325	77	45	P55K	71	75	P75K	76	841	488	X6	<72	X6	X6				
130B5169	130B5287																	
130B5025	130B5326	87	55	P75K	89				962	692	X6	<72	X6	X6				
130B5170	130B5288																	
130B5026	130B5327	109	75	P90K	110	90	P90K	104	1080	743	X6	<72	X6	X6				
130B5172	130B5289																	
130B5028	130B5328	128	90	P110	130	110	P110	126	1194	864	X6	<72	X6	X6				
130B5195	130B5290																	
130B5029	130B5329	155	110	P132	158	132	P132	150	1288	905	X7	<72	X7	X7				
130B5196	130B5291																	
130B5042	130B5330	197	132	P160	198	160	P160	186	1406	952	X7	<72	X7	X7				
130B5197	130B5292																	
130B5066	130B5331	240	160	P200	245	200	P200	234	1510	1175	X8	<75	X8	X8				
130B5198	130B5293																	
130B5076	130B5332	296	200	P250	299	250	P250	280	1852	1288	X8	<75	X8	X8				
130B5199	130B5294																	

Table 5.9 500-690V,50Hz

Code number AHF005 IP00/IP20	Code number AHF010 IP00/IP20	Filter current rating			VLT Power and Current Ratings					Losses			Frame size	
		50Hz A	Typical motor size kW	500-550V		551-690V		AHF005 W	AHF010 W	Acoustic noise dBa	AHF005	AHF010	Frame size	Frame size
				kW	A	kW	A							
2 x 130B5042	130B5333	366	250	P315	355	315/35	P315/	333/368	2812	1542				
2 x 130B5197	130B5295					5	P355							
2 x 130B5042	130B5334	395	315	P355	381	400			2812	1852				
2 x 130B5197	130B5296													
130B5042	130B5330													
+ 130B5066	+ 130B5331													
130B5197	130B5292	437	355	P400	413	500	P400	395	2916	2127				
+ 130B5198	+ 130B5293													
130B5066	130B5331													
+ 130B5076	+ 130B5332													
130B5198	130B5292	536	400	P450	504	560	P500	482	3362	2463				
+ 130B5199	+ 130B5294													
2 x 130B5076	2 x 130B5332	592	450	P500	574	630	P560	549	3704	2576				
2 x 130B5199	2 x 130B5294													
130B5076	130B5332													
+ 2x130B5042	+ 130B5333	662	500	P560	642	710	P630	613	4664	2830				
130B5199	130B5294													
+ 2 x 130B5197	+ 130B5295													
4 x 130B5042	2 x 130B5333	732	560	P630	743	800	P710	711	5624	3084				
4 x 130B5197	2 x 130B5295													
3 x 130B5076	3 x 130B5332	888	670	P710	866	900	P800	828	5556	3864				
3 x 130B5199	3 x 130B5294													
2 x 130B5076	2 x 130B5332													
+ 2 x 130B5042	+ 130B5333	958	750	P800	962	1000	P900	920	6516	4118				
2 x 130B5199	2 x 130B5294													
+ 2 x 130B5197	+ 130B5295													
6 x 130B5042	3 x 130B5333	1098	850	P1M0	1079		P1M0	1032	8436	4626				
6 x 130B5197	3 x 130B5295													

Table 5.10 500-690V/50Hz

## 5.2.1 Accessories

IP21/NEMA1 enclosure kits for the IP20 filters are available and listed here:

Danfoss part number	IP21/NEMA1 kit for IP20 enclosure
130B3274	X1
130B3275	X2
130B3276	X3
130B3277	X4
130B3278	X5
130B3279	X6
130B3281	X7
130B3282	X8

The kit consists of two parts.

A top plate that prevents vertically falling drops of water and dirt from entering the filter and a terminal cover ensuring touch safe terminals. The terminal cover is prepared for installation of a contactor for capacitor disconnect.

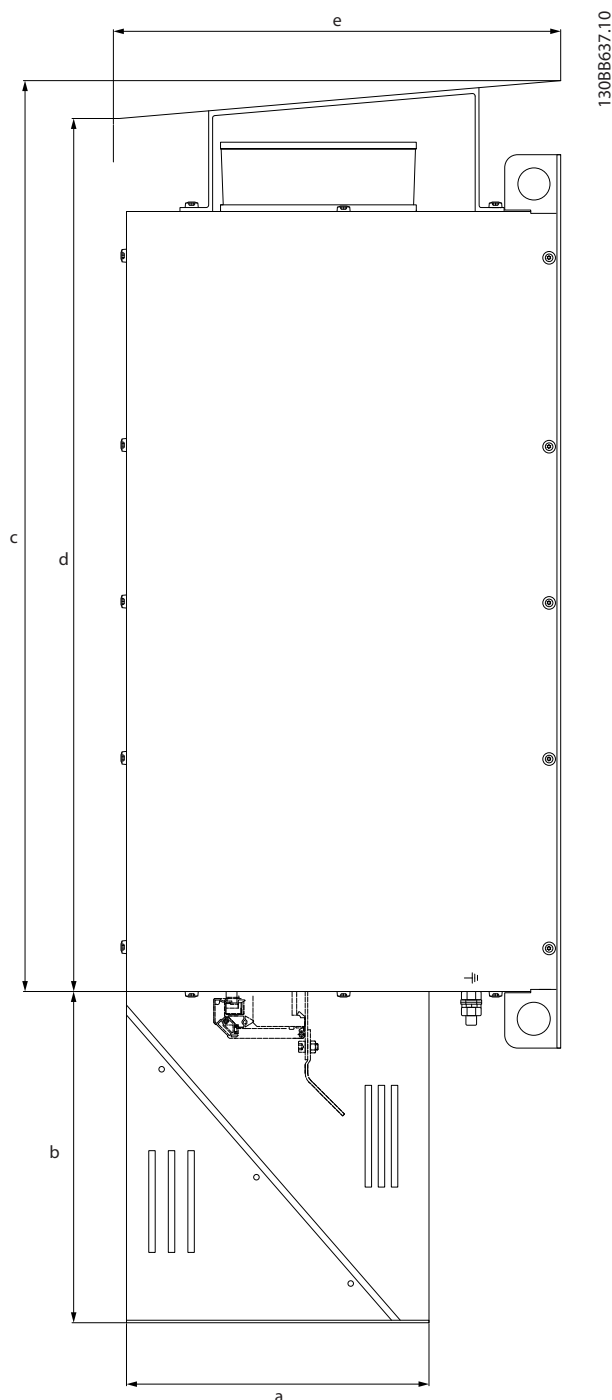

Enclosure type	a (mm)	b (mm)	c (mm)	d (mm)	e (mm)
X1	120	160	329.5	344.5	215.5
X2	190	180	433.5	448.5	257.5
X3	145	210	543.5	558.5	252
X4	230	230	573.5	558.5	343
X5	230	250	681.5	696.5	343
X6	300	270	681.5	696.5	410
X7	300	320	796.5	811.5	458.5
X8	400	350	796.5	811.5	553

## NOTE

The NEMA 1 cover is designed for the mounting of Danfoss contactors.

When using non Danfoss contactors, please observe the dimensions of the NEMA 1 terminal cover and ensure that there is space for the contactor.

## 5.3 General Specification

### 5.3.1 General Technical Data

Supply voltage tolerance	± 10%
Supply frequency tolerance	+5%/-1.5%
Overload capability	160% for 60 sec.
Efficiency	>0.98
THiD*	AHF005 < 5% AHF010 < 10%
Cos φ of I <sub>L</sub>	0.5 cap at 25% I <sub>AHF,N</sub> 0.8 cap at 50% I <sub>AHF,N</sub> 0.85 cap at 75% I <sub>AHF,N</sub> 0.99 cap at 100% I <sub>AHF,N</sub> 1.00 cap at 160% I <sub>AHF,N</sub>
Power derating	Temperature - see derating curve below. 1000m altitude above sea level < h < 2000m = 5% per 1000m

## NOTE

The reduction of the low harmonic current emission to the rated THiD implies that the THvD of the non-influenced mains voltage is lower than 2% and the ratio of short circuit power to installed load (R<sub>SCE</sub>) is at least 66. Under these conditions the THiD of the mains current of the frequency converter is reduced to 10% or 5% (typical values at nominal load). If these conditions are not or only partially fulfilled, a significant reduction of the harmonic components can still be achieved, but the rated THiD values may not be observed.

Enclosure Type	Dimensions in mm		
	A (height)	B (width)	C (depth)
X1	332	190	206
X2	436	232	248
X3	594	378	242
X4	634	378	333
X5	747	418	333
X6	778	418	396
X7	909	468	449
X8	911	468	549

Table 5.11 Enclosure Dimensions

### 5.3.2 Environmental Data

Surroundings	
Ambient temperature during full-scale operation	5°C... + 45°C - without derating 5°C... + 60°C - with derating
Temperature during storage/transport	-25°C... + 65°C - transport -25°C... + 55°C - storage
Max. altitude above sea level	1000m (without derating) Between 1000m and 2000m (with derating)
Max. relative humidity	Humidity class F without condensation - 5% - 85% - Class 3K3 (non-sondensing) during operation
Insulation strength	Overvoltage category III according to ENG 61800-5-1
Packaging	DIN55468 for transport packaging materials

5

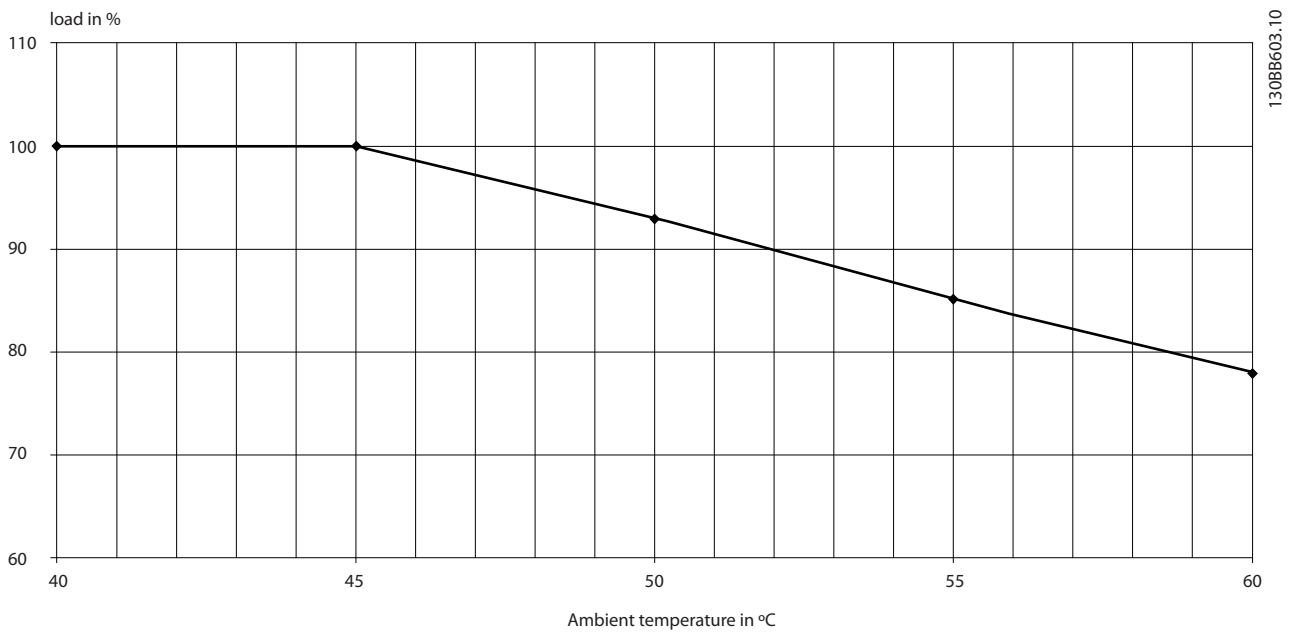

Illustration 5.1 Temperature Derating Curve

## 6 How to Install

### 6.1 Mechanical Mounting

#### 6.1.1 Safety Requirements of Mechanical Installation

##### NOTE

Please observe the filter weight and ensure that proper lifting equipment is used.

##### NOTE

When installing the filter use the lifting eyes on both sides to lift the filter.

##### NOTE

Do not use other parts (terminals, enclosures, etc.).

#### 6.1.2 Mounting

The filters are available in IP00 and IP20 and for both IP ratings the following guidance must be followed during installation.

- All filters must be mounted vertically with the terminals at the bottom
- Do not mount the filter close to other heating elements or heat sensitive material (such as wood)

##### IP00

- The surface temperature of the IP00 filters can exceed 70°C and a hot surface warning label is placed on the filter

##### IP20

- Top and bottom clearance is minimum 150mm
- The surface temperature of the IP20 filters does not exceed 70°C
- The filter can be side-by-side mounted with the frequency converter and there is no requirement for spacing between them.

#### 6.1.3 Recommendations for Installation in Industrial Enclosures

To avoid high frequency noise coupling keep a minimum distance of 150mm (5.91 inches) to

- mains/supply wires
- motor wires of frequency converter
- control- and signal wires (voltage range < 48V)

To obtain low impedance HF-connections, grounding, screening and other metallic connections (e.g. mounting plates, mounted units) should have a surface as large as possible to metallic ground. Use grounding and potential equalisation wires with a cross section as large as possible (min. 10mm<sup>2</sup>) or thick grounding tapes. Use copper or tinned copper screened wires only, as steel screened wires are not suitable for high frequency applications. Connect the screen with metal clamps or metal glands to the equalisation bars or PE-connections.

Inductive switching units (relay, magnetic contactor etc.) must always be equipped with varistors, RC-circuits or suppressor diodes.

#### 6.1.4 Ventilation

The filters are cooled by means of air circulation. Consequently the air needs to be able to move freely above and below the filter.

When mounting the filters in panels or other industrial enclosures it must be ensured that there is a sufficient airflow through the filter to reduce the risk of overheating the filter and the surrounding components.

If other heat sources (such as frequency converters) are installed in the same enclosure, the heat they generate also needs to be taken into account when dimensioning the cooling of the enclosure.

The filters have to be mounted on a wall in order to guide air through the gap between the wall and the filter. In installations (e.g. panels) where the filter is mounted on rails, the filter will not be sufficiently cooled because of false airflow and therefore a back plate can be ordered separately. See following illustration.

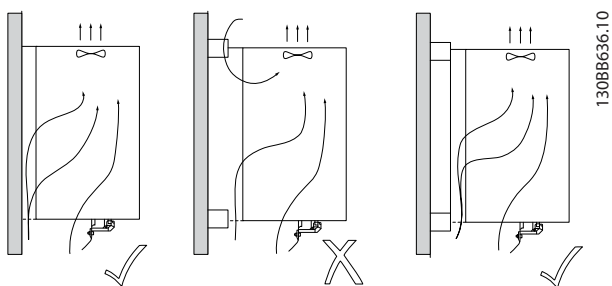

Danfoss part number	Back plate
130B3283	X1
130B3284	X2
130B3285	X3
130B3286	X4
130B3287	X5 and X6
130B3288	X7 and X8

IP20: Ventilation fan mounted:

380V, 60Hz 400V, 50Hz	460V, Hz	Fan	
Current	Current	AHF010	AHF005
[A]	[A]		
10	10	no	no
14	14	no	no
22	19	inside	outside
29	25	inside	outside
34	31	inside	inside
40	36	inside	inside
55	48	inside	inside
66	60	inside	inside
82	73	inside	inside
96	95	inside	inside
133	118	inside	inside
171	154	inside	inside
204	183	inside	outside
251	231	inside	outside
304	291	inside	outside
325	355	inside	outside
380	380	inside	outside
480	436	inside	outside

600V, 60Hz 500-690V, 50Hz

Current	Fan	
[A]	AHF010	AHF005
15	inside	inside
20	inside	inside
24	inside	inside
29	inside	inside
36	inside	outside
50	inside	inside
58	inside	outside
77	inside	inside
87	inside	inside
109	inside	inside
128	inside	outside
155	inside	outside
197	inside	outside
240	inside	outside
296	inside	outside
366	outside	-
395	outside	-

## 380-480V.50 and 60Hz

Voltage and frequency		AHF005			AHF010		
380-415V, 50 and 60Hz	440-480, 60Hz	Thermal	Air speeds	Air volume	Thermal	Air speeds	Air volume
[A]		losses in W	m/s	m <sup>3</sup> /s	losses in W	m/s	m <sup>3</sup> /s
10	10	131	2	0,0118	93	2	0,0084
14	14	184	2	0,0166	118	2	0,0106
22	19	258	2	0,0232	206	2	0,0185
29	25	298	2	0,0268	224	2	0,0202
34	31	335	2	0,0302	233	2	0,0210
40	36	396	2	0,0356	242	2	0,0218
55	48	482	2	0,0434	274	2	0,0247
66	60	574	2	0,0517	352	2	0,0317
82	73	688	2	0,0619	374	2	0,0337
96	95	747	2	0,0672	428	2	0,0385
133	118	841	2	0,0757	488	2	0,0439
171	154	962	2	0,0866	692	2	0,0623
204	183	1080	2,5	0,0972	743	2,5	0,0669
251	231	1194	2,5	0,1075	864	2,5	0,0778
304	291	1288	2,5	0,1159	905	2,5	0,0815
325	355	1406	2,5	0,1265	952	2,5	0,0857
381	380	1510	2,5	0,1359	1175	2,5	0,1058
480	436	1852	2,5	0,1667	1542	2,5	0,1388

## 600V,60Hz

Voltage and frequency		AHF005			AHF010		
500-690V, 50Hz	600V, 60Hz	Thermal	Air speeds	Air volume	Thermal	Air speeds	Air volume
[A]		losses in W	m/s	V(m <sup>3</sup> /s)	losses in W	m/s	V(m <sup>3</sup> /s)
15		298	2	0,0268	224	2	0,0202
20		335	2	0,0302	233	2	0,0210
24		396	2	0,0356	242	2	0,0218
29		482	2	0,0434	274	2	0,0247
36		574	2	0,0517	352	2	0,0317
50		688	2	0,0619	374	2	0,0337
58		747	2	0,0672	428	2	0,0385
77		841	2	0,0757	488	2	0,0439
87		962	2	0,0866	692	2	0,0623
109		1080	2	0,0972	743	2	0,0669
128		1194	2	0,1075	864	2	0,0778
155		1288	2,5	0,1159	905	2,5	0,0815
197		1406	2,5	0,1265	952	2,5	0,0857
240		1510	2,5	0,1359	1175	2,5	0,1058
296		1852	2,5	0,1667	1288	2,5	0,1159
366		-	-	-	1542	2,5	0,1388
395		-	-	-	1852	2,5	0,1667



## 6.2 Electrical Installation

### 6.2.1 Over Temperature Protection

The Danfoss harmonic filters AHF005 and AHF010 are all equipped with a galvanic isolated switch (PELV) that is closed under normal operating conditions and open if the filter is overheated.

#### NOTE

The over temperature protection must be used to prevent damage of the filter caused by over temperature. An immediate stop or a controlled ramp down within max. 30 sec. has to be performed to prevent filter damage.

There are many ways the switch can be used and one example is to connect terminal A of the harmonic filter to terminal 12 or 13 (voltage supply digital input, 24V) of the Danfoss frequency converter and terminal B to terminal 27. Program digital input terminal 27 to *Coast Inverse*. The frequency converter will coast the motor and thereby unload the filter if an over temperature is detected. Alternatively use terminal 12/33 and set *1-90 Motor Thermal Protection*.

6

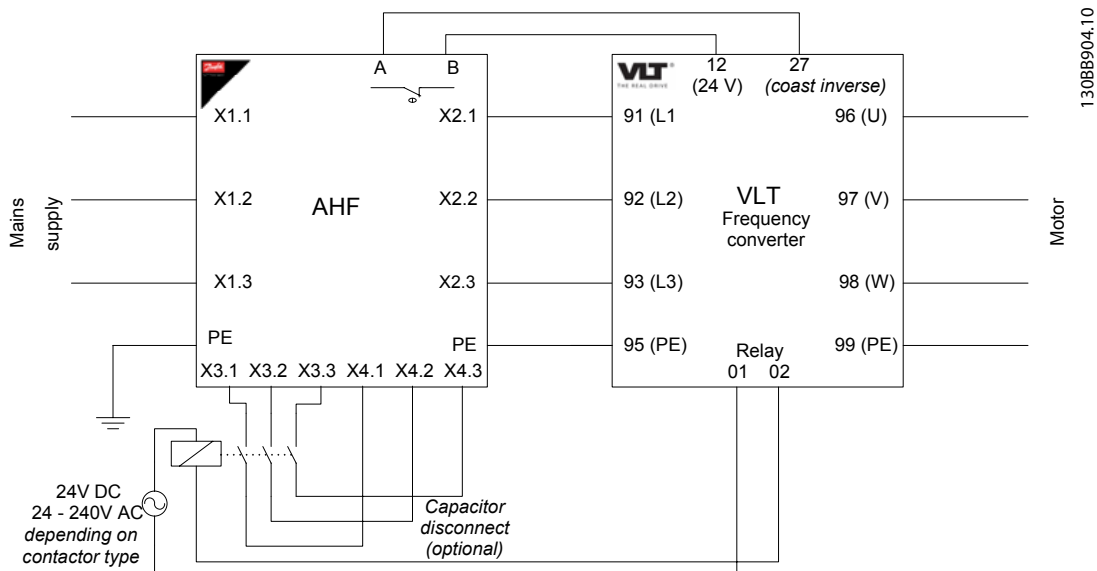

Illustration 6.1 Connection Diagram

#### NOTE

The maximum rating of the over temperature contactor is 250V AC and 10A.

### 6.2.2 Capacitor Disconnect

The power factor of the harmonic filter AHF 005/010 is decreasing with decreasing load. At no load the power factor is zero and the capacitors produce leading current of approximately 25% of rated the filter current. In applications where this reactive current is not acceptable the terminals X3.1, X3.2, X3.3 and X4.1, X4, X4.3 provide access to the capacitor bank, so it can be disconnected.

Default (on delivery) the wiring will shorten terminal X3.1 with X4.1, X3.2 with X4.2 and X3.3 with X4.3. In the case that no capacitor disconnect is required, no changes should be made to these shorted terminals.

If a disconnection of the capacitors is required a three-phase contactor should be placed between terminals X3 and X4. It is recommended to use AC3 contactors.

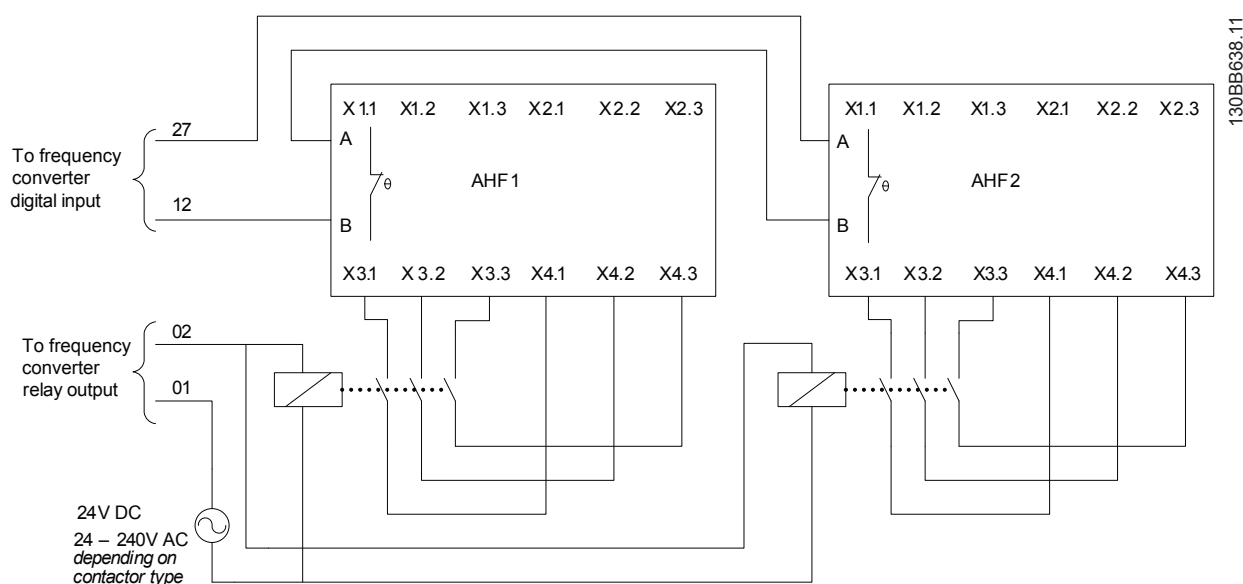

6

#### NOTE

It is not allowed to use one common 3 poled contactor with several paralleled Advanced Harmonic Filters.

#### NOTE

The AHF filters in stand-by and under low load conditions, when the capacitors are not disconnected, boost the input voltage with up to 5%. That means that the voltage at the drive terminals is up to 5% higher than the voltage at the input of the filter. This should be considered at the design of the installation. Special care should be taken in 690V applications where the voltage tolerance of the drive is reduced to + 5%, unless a capacitor disconnect is used.

#### NOTE

Only switch the contactor at less than 20% output power. Allow minimum 25 sec. for the capacitors to discharge before re-connecting

Current rating 380-415V, 50 and 60Hz	Current rating 440-480V, 60Hz	Danfoss Contactors for AHF005 and AHF010	Alternative type AC3
A	A	Type	Contactor rating <sup>1)</sup> KVAr
10	10	CI 9	1
14	14	CI 9	2
22	19	CI 9	4
29	25	CI 9	6
34	31	CI 16	7
40	36	CI 16	7
55	48	CI 16	9
66	60	CI 61	11
82	73	CI 61	15
96	95	CI 61	17
133	118	CI 61	22
171	154	CI 61	29
204	183	CI 61	36
251	231	CI 110	44
304	291	CI 110	51
325	355	CI 110	58
380	380	CI 110	66
480	436	CI 141	88

<sup>1)</sup> min. 50% of the nominal load

### 6.2.3 Wiring

Supply voltage must be connected to the terminals X1.1, X1.2 and X1.3. The frequency converter supply terminals L1, L2 and L3 must be connected to the filter terminals X2.1, X2.2 and X2.3

#### Paralleling of frequency converters

If several frequency converters are to be connected to one harmonic filter, the connection method is similar to the connection described above. The supply terminals L1, L2 and L3 of the frequency converters must be connected to the filter terminals X2.1, X2.2 and X2.3.

### NOTE

**Use cables complying with local regulations.**

#### Paralleling of filters

If the mains input current of the frequency converter exceeds the nominal current of the largest harmonic filter, several harmonic filters can be paralleled to achieve the necessary current rating – see *Electrical Data* tables.

Supply voltage be connected to the terminals X1.1, X1.2 and X1.3 of the filters. The frequency converter supply terminals L1, L2 and L3 must be connected to the filters terminals X2.1, X2.2 and X2.3

#### Terminals and cables

The following tables show the terminal types, cable cross section, tightening torque, etc.

Current in A	Main terminals				Capacitor disconnect terminals			
	Clamp mains terminals	Cable cross-section in mm <sup>2</sup>	Cable end	Torque in Nm	Clamp capacitor disconnect terminals	Cable cross-section in mm <sup>2</sup>	Cable end	Torque in Nm
10	WDU 6	0.5-10	cable end sleeve	1.6	WDU 2.5	0.5-4	cable end sleeve	0.8
14	WDU 6	0.5-10	cable end sleeve	1.6	WDU 2.5	0.5-4	cable end sleeve	0.8
22	WDU 6	0.5-10	cable end sleeve	1.6	WDU 2.5	0.5-4	cable end sleeve	0.8
29	WDU 6	0.5-10	cable end sleeve	1.6	WDU 2.5	0.5-4	cable end sleeve	0.8
34	WDU 16	1.5-25	cable end sleeve	2.4	WDU 10	1.5-16	cable end sleeve	2.4
40	WDU 16	1.5-25	cable end sleeve	2.4	WDU 10	1.5-16	cable end sleeve	2.4
55	WDU 16	1.5-25	cable end sleeve	2.4	WDU 10	1.5-16	cable end sleeve	2.4
66	WDU 35	2.5-50	cable end sleeve	4.5	WDU 16	1.5-16	cable end sleeve	2.4
82	WDU 35	2.5-50	cable end sleeve	4.5	WDU 16	1.5-16	cable end sleeve	2.4
96	WDU 50 N	10-70	cable end sleeve	6	WDU 16	1.5-16	cable end sleeve	2.4
133	WDU 50 N	10-70	cable end sleeve	6	WDU 16	1.5-16	cable end sleeve	2.4
171	WFF 70	2.5-95	cable lug M8	12	WDU 35	2.5-50	cable end sleeve	4.5
204	WFF 70	2.5-95	cable lug M8	12	WDU 35	2.5-50	cable end sleeve	4.5
251	WFF 300	25-300	cable lug M16	60	WDU 95 N	16-150	cable end sleeve	20
304	WFF 300	25-300	cable lug M16	60	WDU 95 N	16-150	cable end sleeve	20
325	WFF 300	25-300	cable lug M16	60	WDU 95 N	16-150	cable end sleeve	20
380	WFF 300	25-300	cable lug M16	60	WDU 95 N	16-150	cable end sleeve	20
480	WFF 300	25-300	cable lug M16	60	WDU 95 N	16-150	cable end sleeve	20

Table 6.1 380 - 415V, 50 and 60Hz

Current in A	Main terminals				Capacitor disconnect terminals			
	Clamp mains terminals	Cable cross-section in mm <sup>2</sup>	Cable end	Torque in Nm	Clamp capacitor disconnect terminals	Cable cross-section in mm <sup>2</sup>	Cable end	Torque in Nm
10	WDU 6	0.5-10	cable end sleeve	1.6	WDU 2.5	0.5-4	cable end sleeve	0.8
14	WDU 6	0.5-10	cable end sleeve	1.6	WDU 2.5	0.5-4	cable end sleeve	0.8
19	WDU 6	0.5-10	cable end sleeve	1.6	WDU 2.5	0.5-4	cable end sleeve	0.8
25	WDU 6	0.5-10	cable end sleeve	1.6	WDU 2.5	0.5-4	cable end sleeve	0.8
31	WDU 16	1.5-25	cable end sleeve	2.4	WDU 10	1.5-16	cable end sleeve	2.4
36	WDU 16	1.5-25	cable end sleeve	2.4	WDU 10	1.5-16	cable end sleeve	2.4
48	WDU 16	1.5-25	cable end sleeve	2.4	WDU 10	1.5-16	cable end sleeve	2.4
60	WDU 35	2.5-50	cable end sleeve	4.5	WDU 16	1.5-25	cable end sleeve	2.4
73	WDU 35	2.5-50	cable end sleeve	4.5	WDU 16	1.5-25	cable end sleeve	2.4
95	WDU 50 N	10-70	cable end sleeve	6	WDU 16	1.5-25	cable end sleeve	2.4
118	WDU 50 N	10-70	cable end sleeve	6	WDU 16	1.5-25	cable end sleeve	2.4
154	WFF 70	2.5-95	cable lug M8	12	WDU 35	2.5-50	cable end sleeve	4.5
183	WFF 70	2.5-95	cable lug M8	12	WDU 35	2.5-50	cable end sleeve	4.5
231	WFF 300	25-300	cable lug M16	60	WDU 95 N	16-150	cable end sleeve	20
291	WFF 300	25-300	cable lug M16	60	WDU 95 N	16-150	cable end sleeve	20
355	WFF 300	25-300	cable lug M16	60	WDU 95 N	16-150	cable end sleeve	20
380	WFF 300	25-300	cable lug M16	60	WDU 95 N	16-150	cable end sleeve	20
436	WFF 300	25-300	cable lug M16	60	WDU 95 N	16-150	cable end sleeve	20

Table 6.2 440 - 480V, 60Hz

### 6.2.4 Fuses

In order to protect the installation against electrical and fire hazards, all filters in an installation must be short-circuit and over-current protected according to national/international regulations.

In applications where filters are paralleled it might be necessary to install fuses in front of each filter and in front of the frequency converter.

To protect both frequency converter and filter please choose the type of fuses recommended in the VLT® Design Guide. The maximum fuse rating per filter size is listed below.

Filter current		Maximum size of fuse
380V, 60Hz 400V, 50Hz	460V, 60Hz	
[A]	[A]	[A]
10	10	16
14	14	35
22	19	35
29	25	50
34	31	50
40	36	63
55	48	80
66	60	125
82	73	160
96	95	250
133	118	250
171	154	315
204	183	350
251	231	400
304	291	500
325	355	630
380	380	630
480	436	800

6.3 Mechanical Dimensions

6.3.1 Sketches

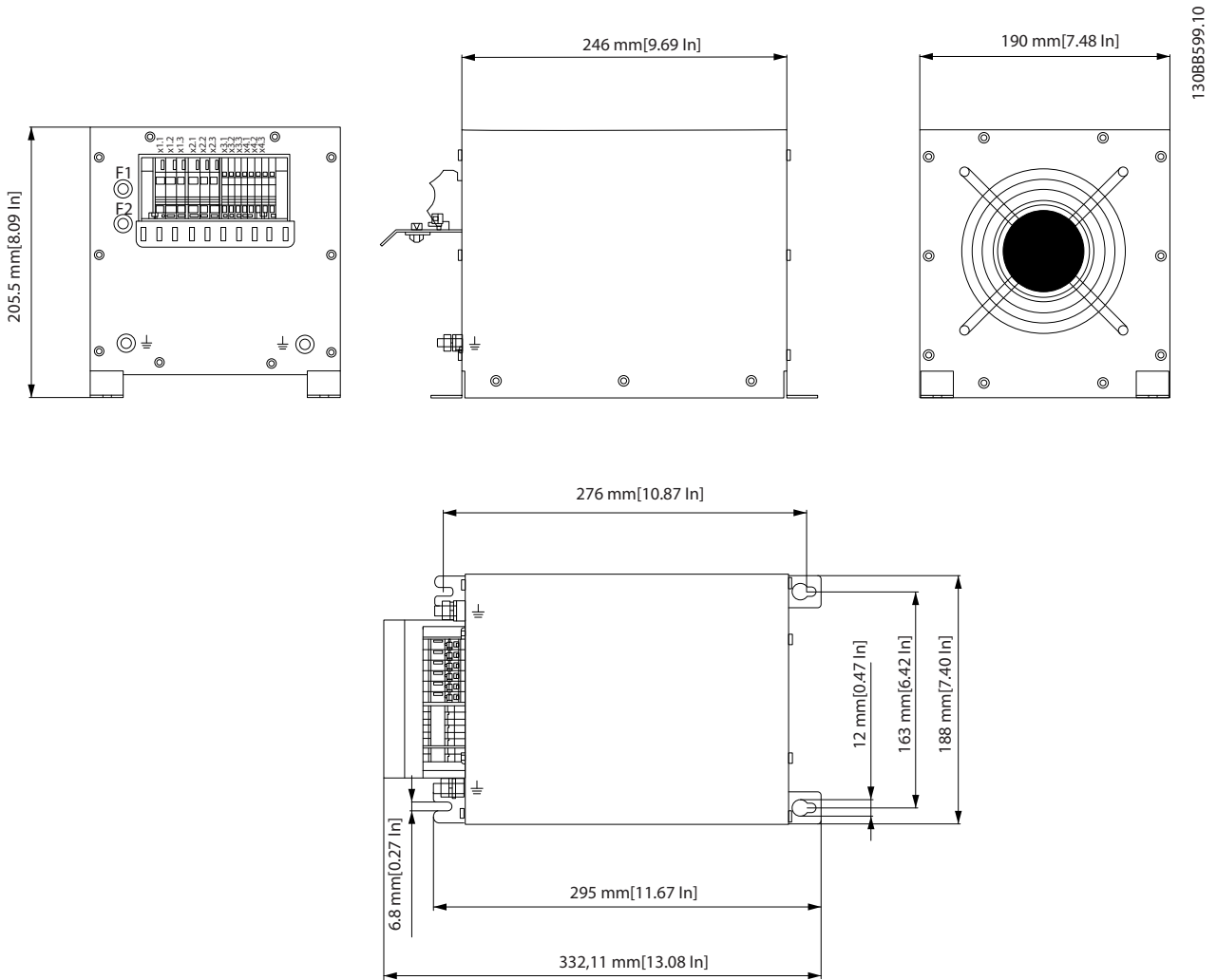

6

Illustration 6.2 X1 No Fan

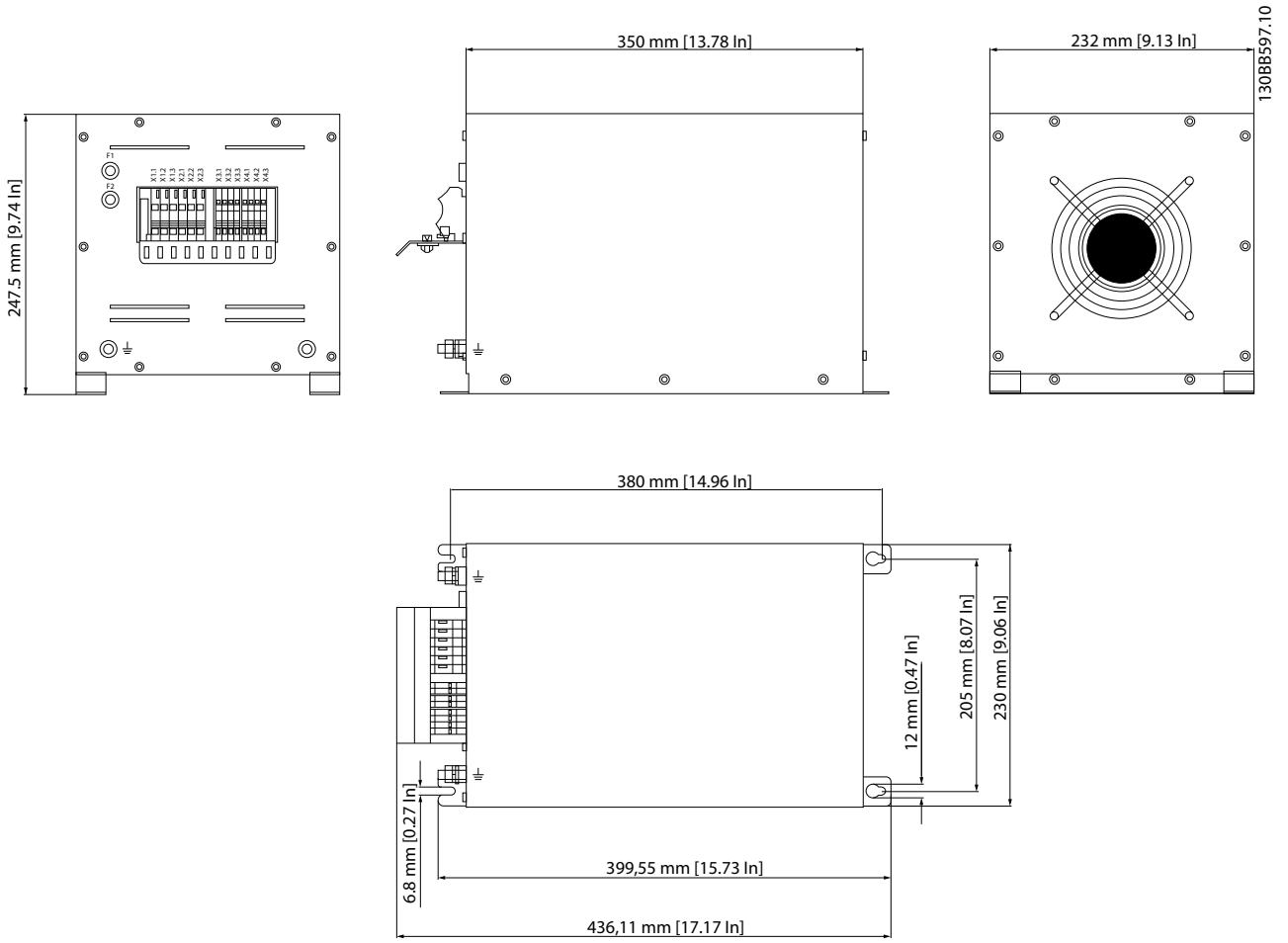

6

Illustration 6.3 X2 Internal Fan

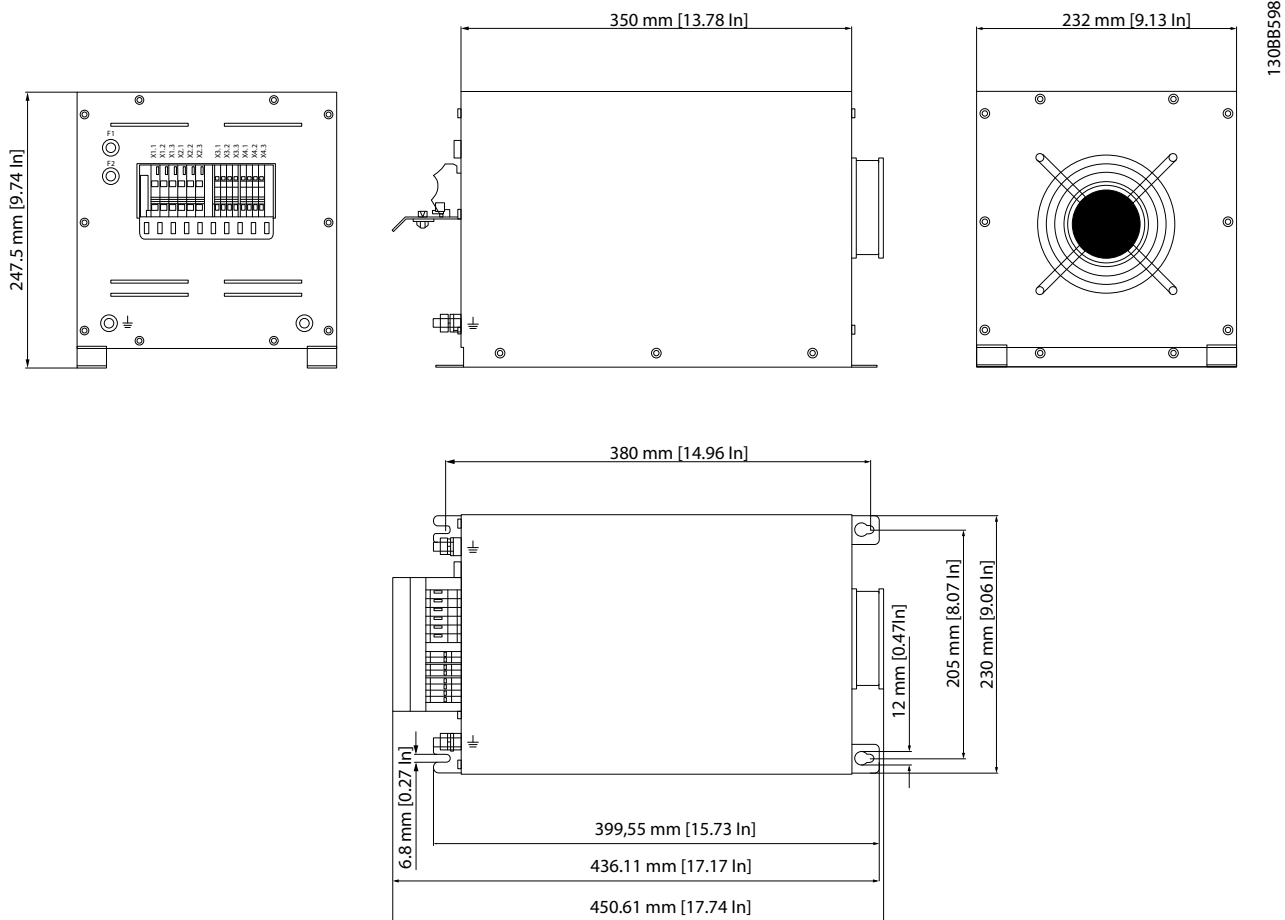

6

Illustration 6.4 X2 External Fan



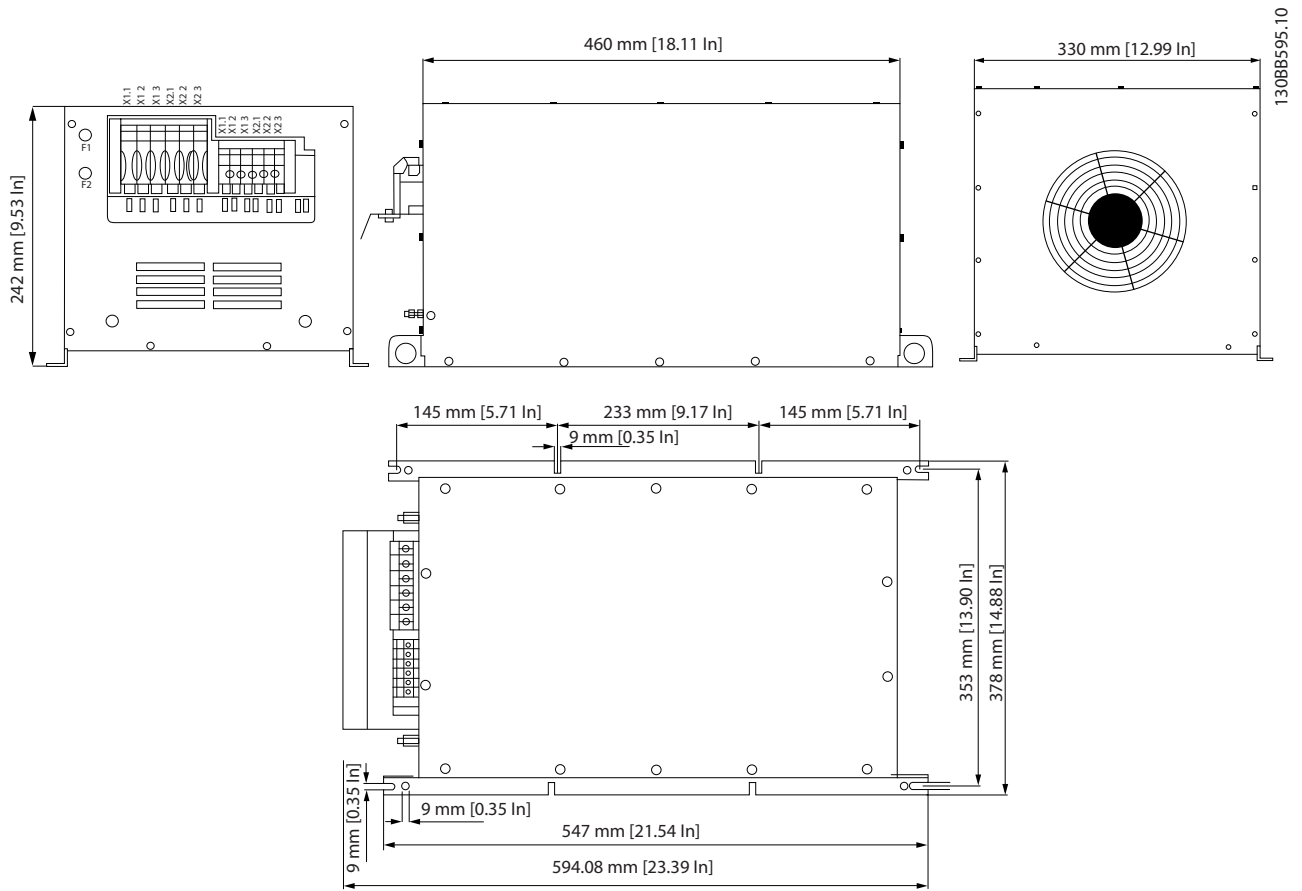
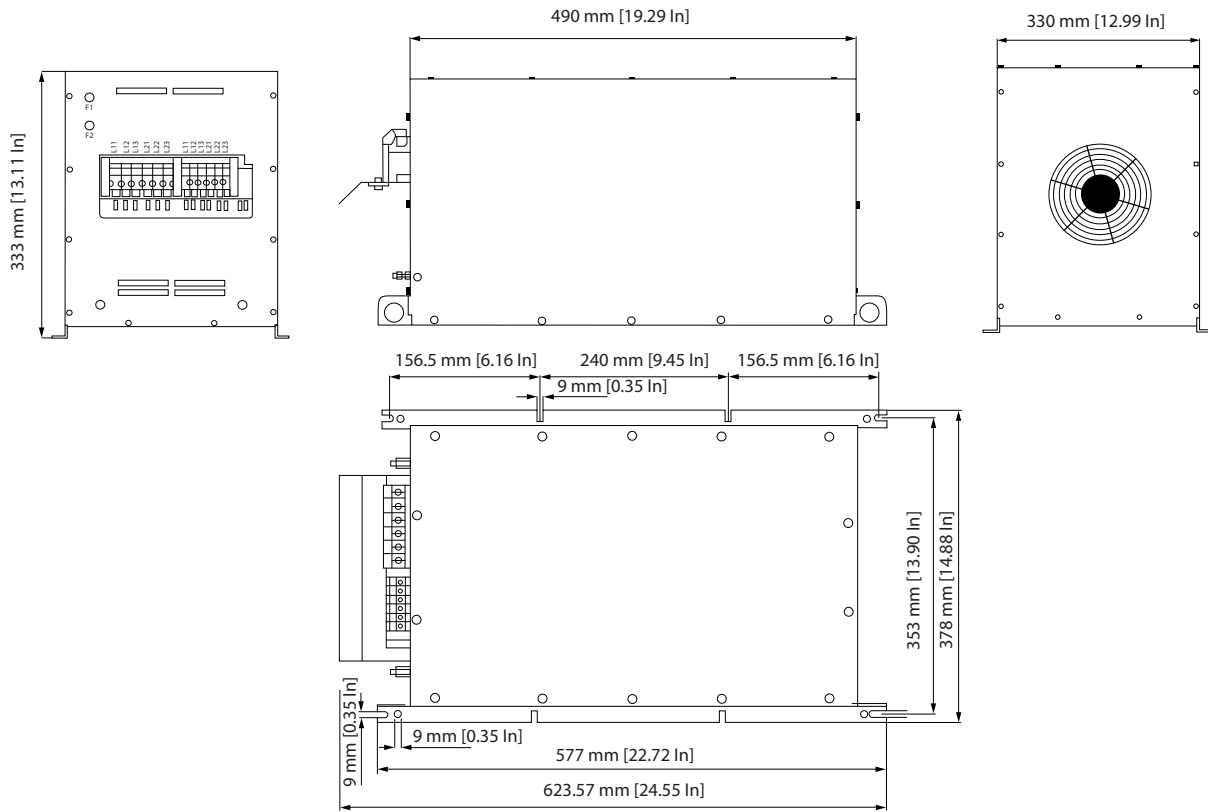

Illustration 6.5 X3 Internal Fan

6



130B8593.10

6

Illustration 6.6 X4 Internal Fan

6

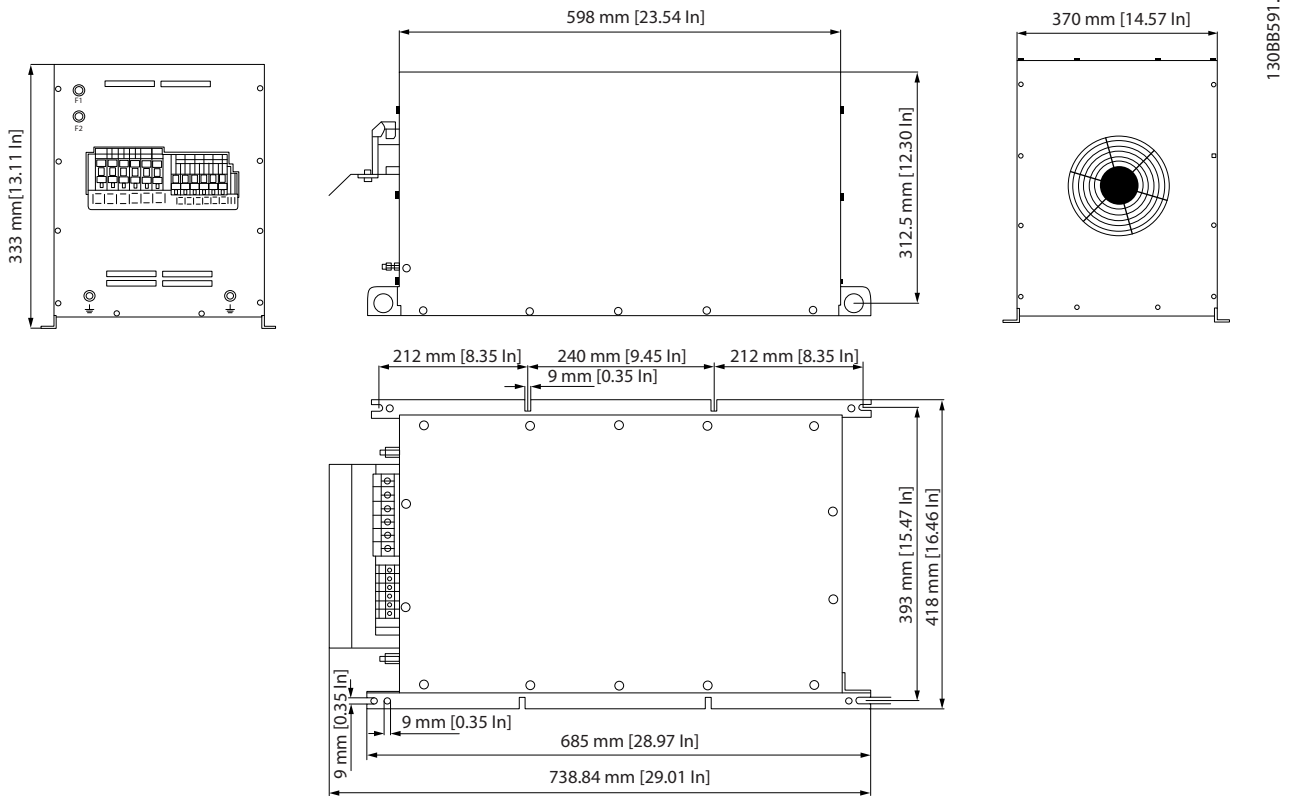

Illustration 6.7 X5 Internal Fan

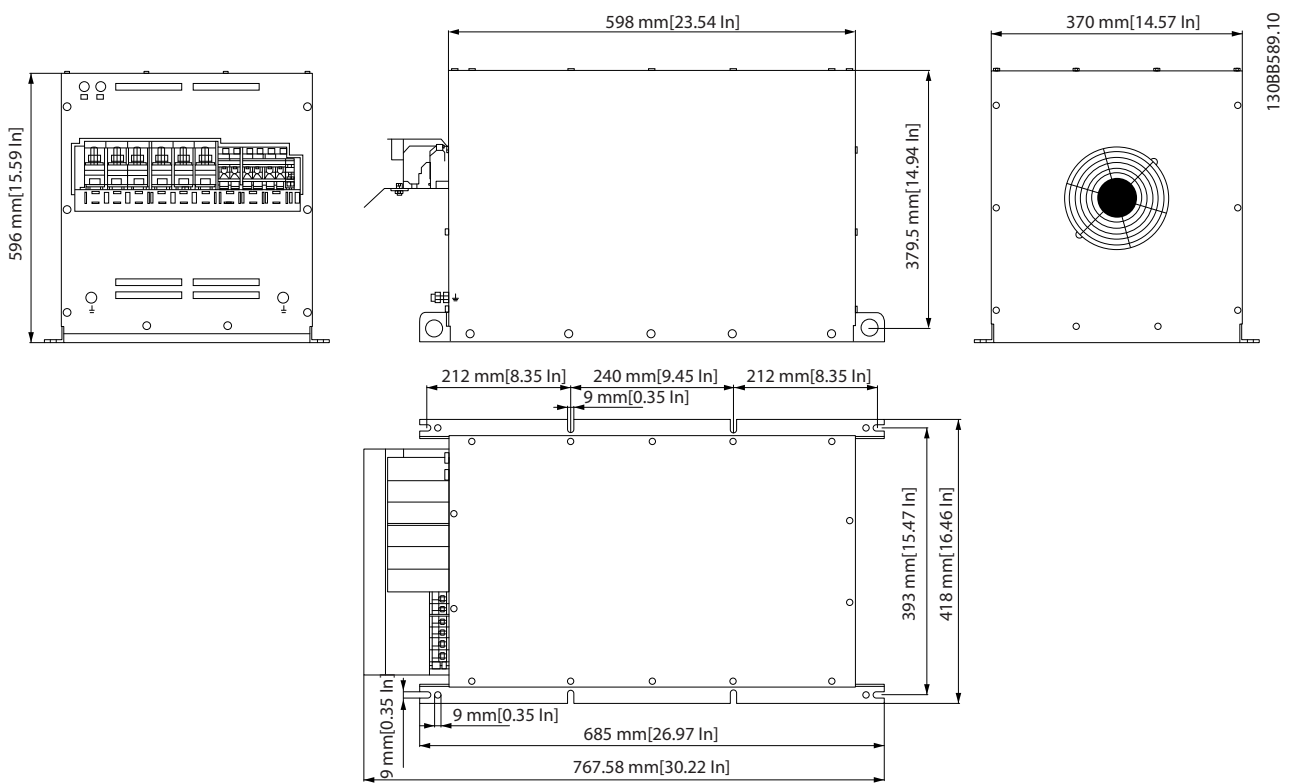
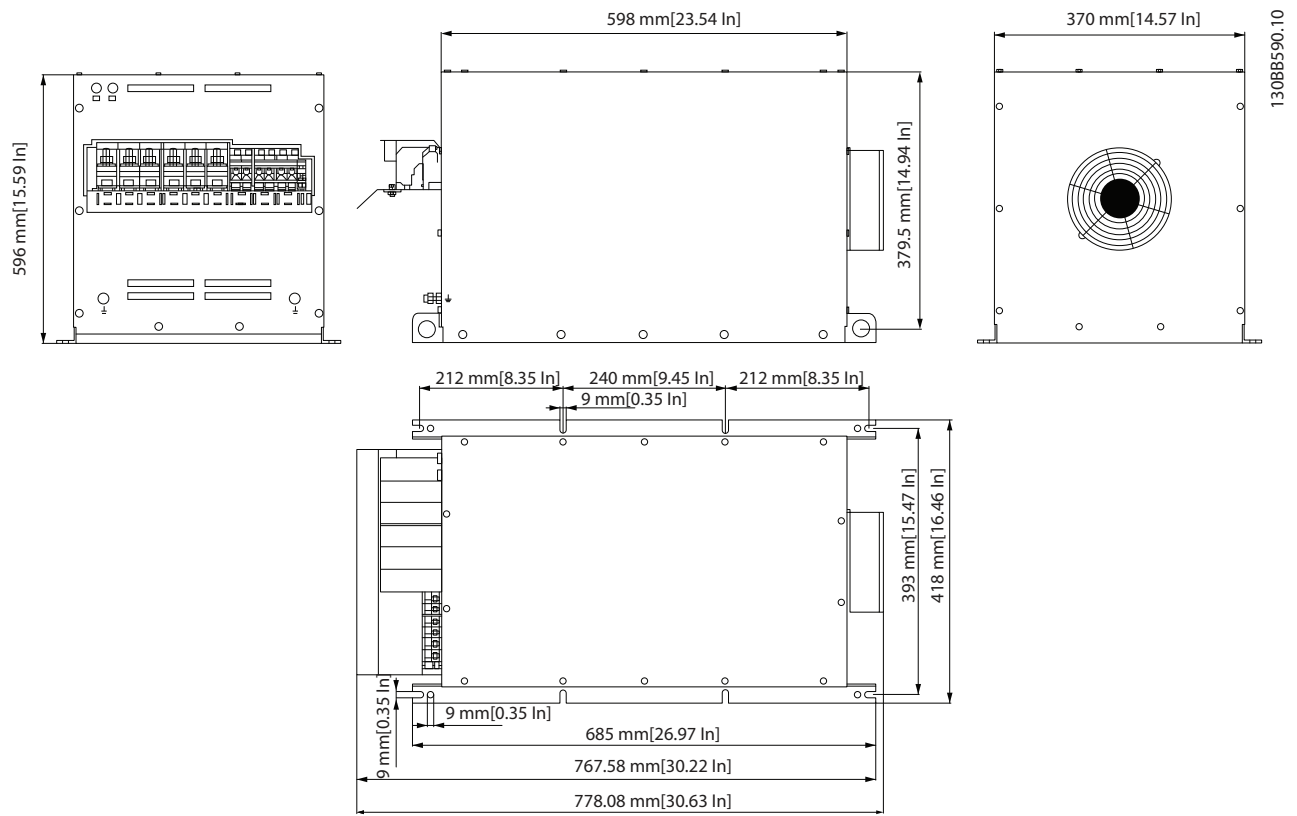
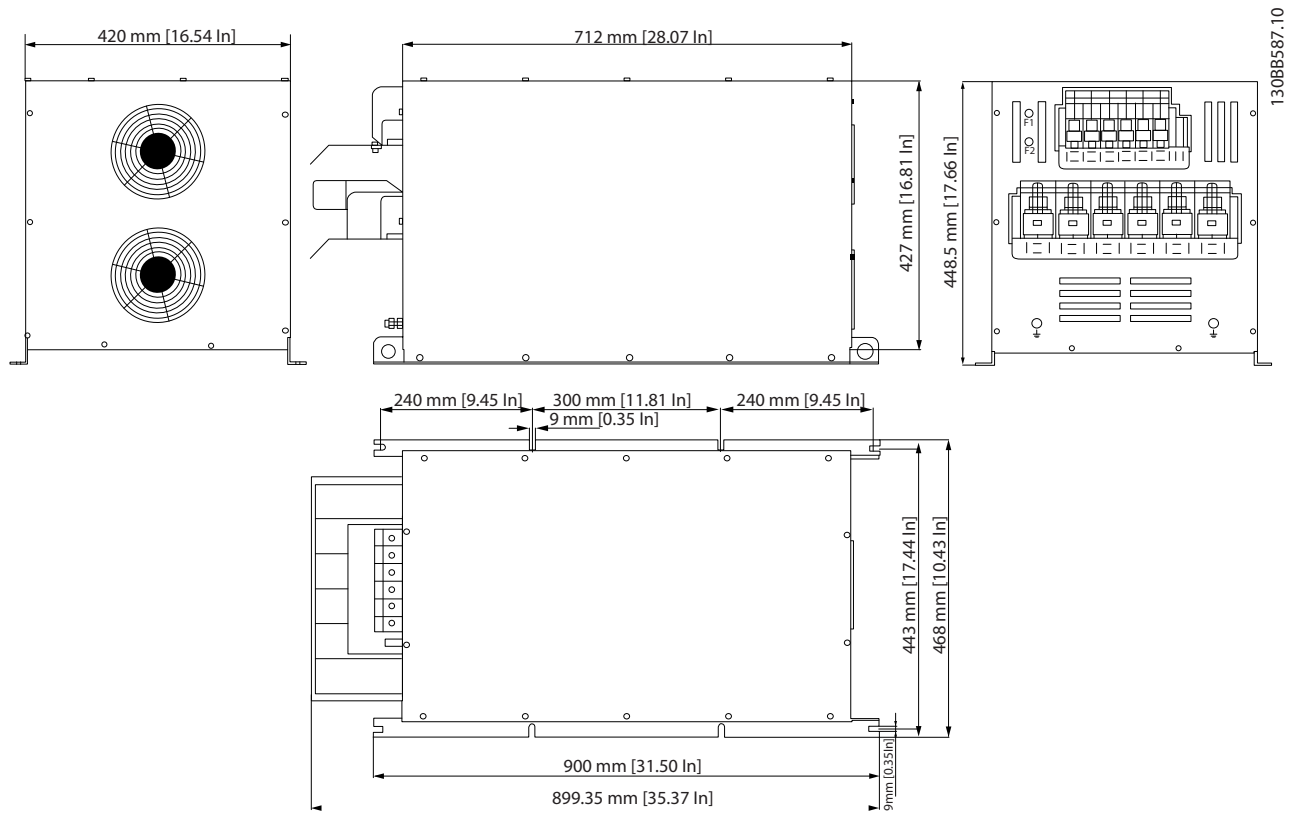

Illustration 6.8 X6 Internal Fan



130BB590.10

Illustration 6.9 X6 External Fan



130BB587.10

Illustration 6.10 X7 Internal Fan

6

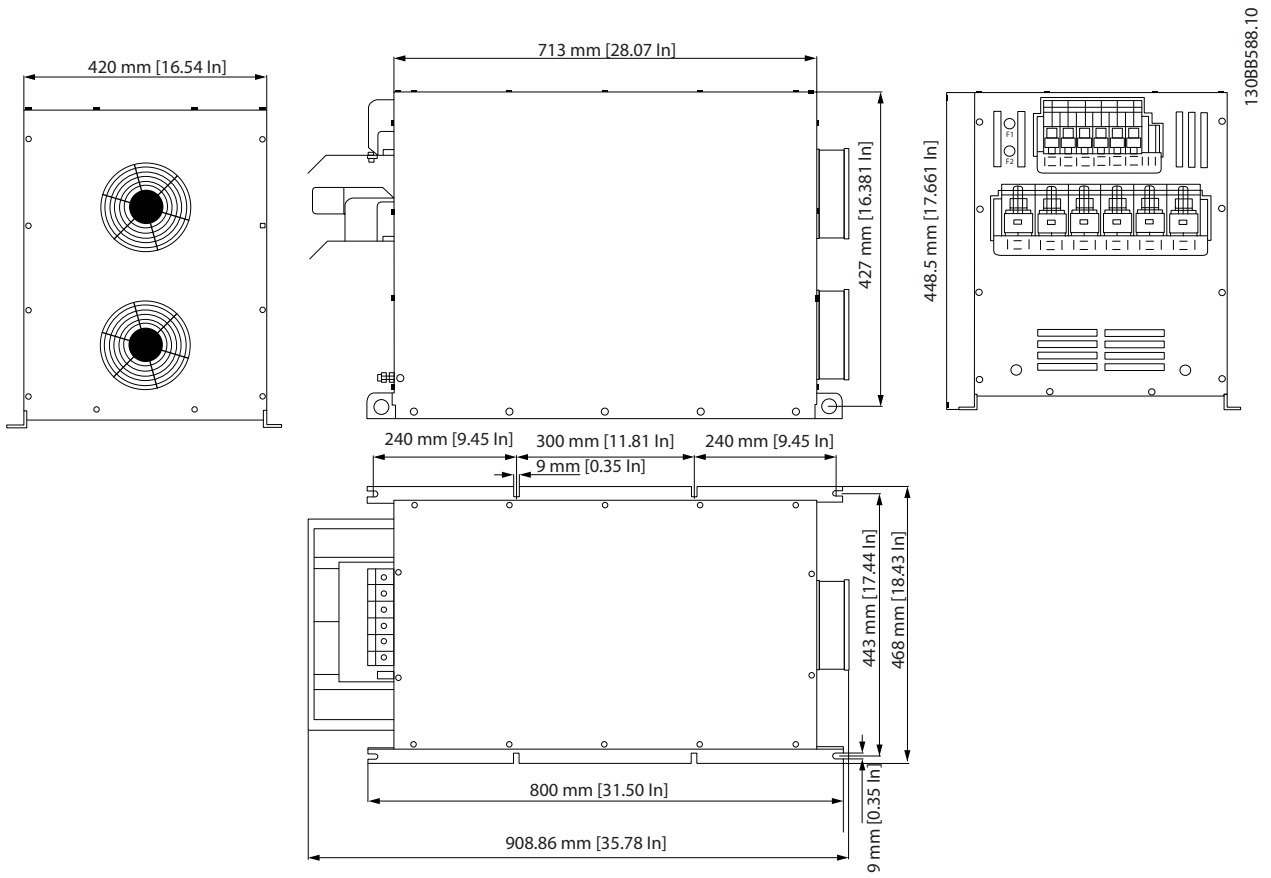

Illustration 6.11 X7 External Fan

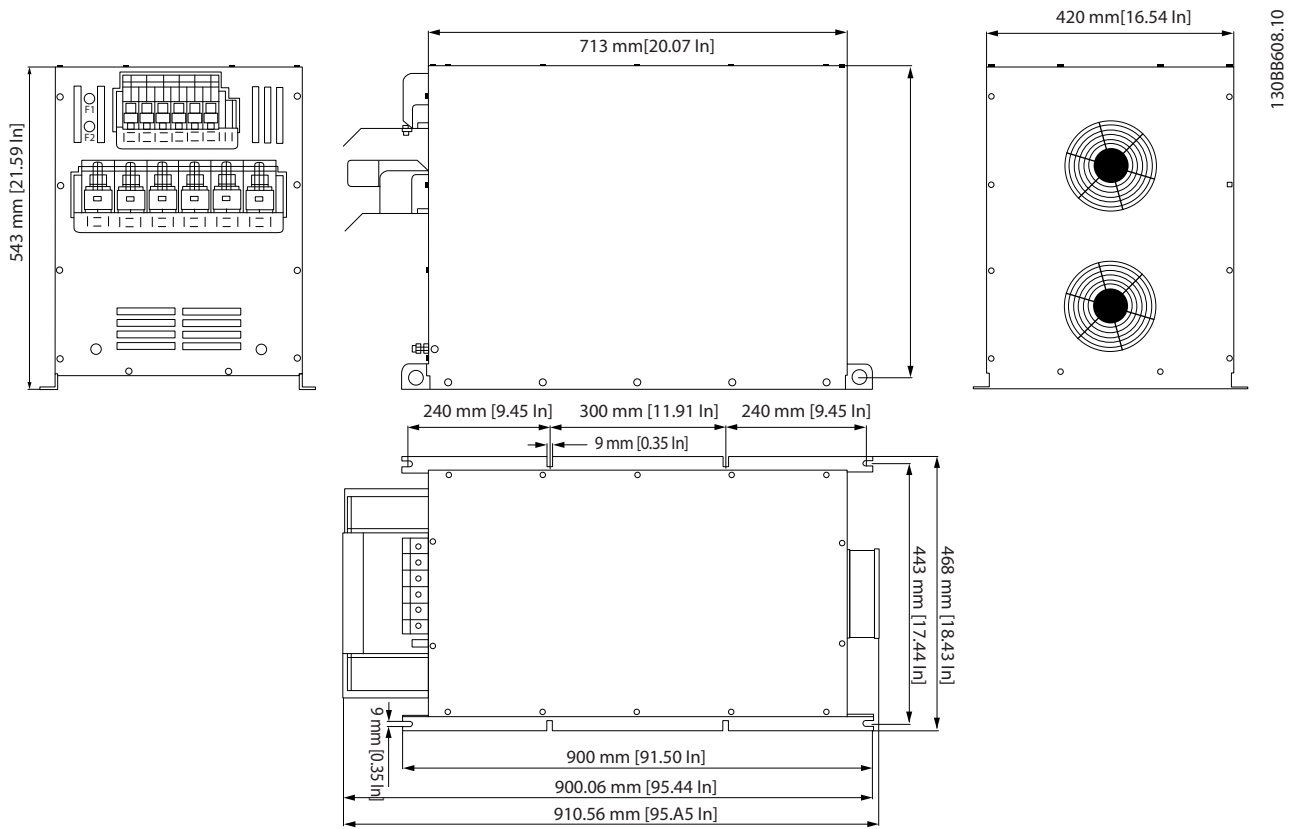

Illustration 6.12 X8 Internal Fan

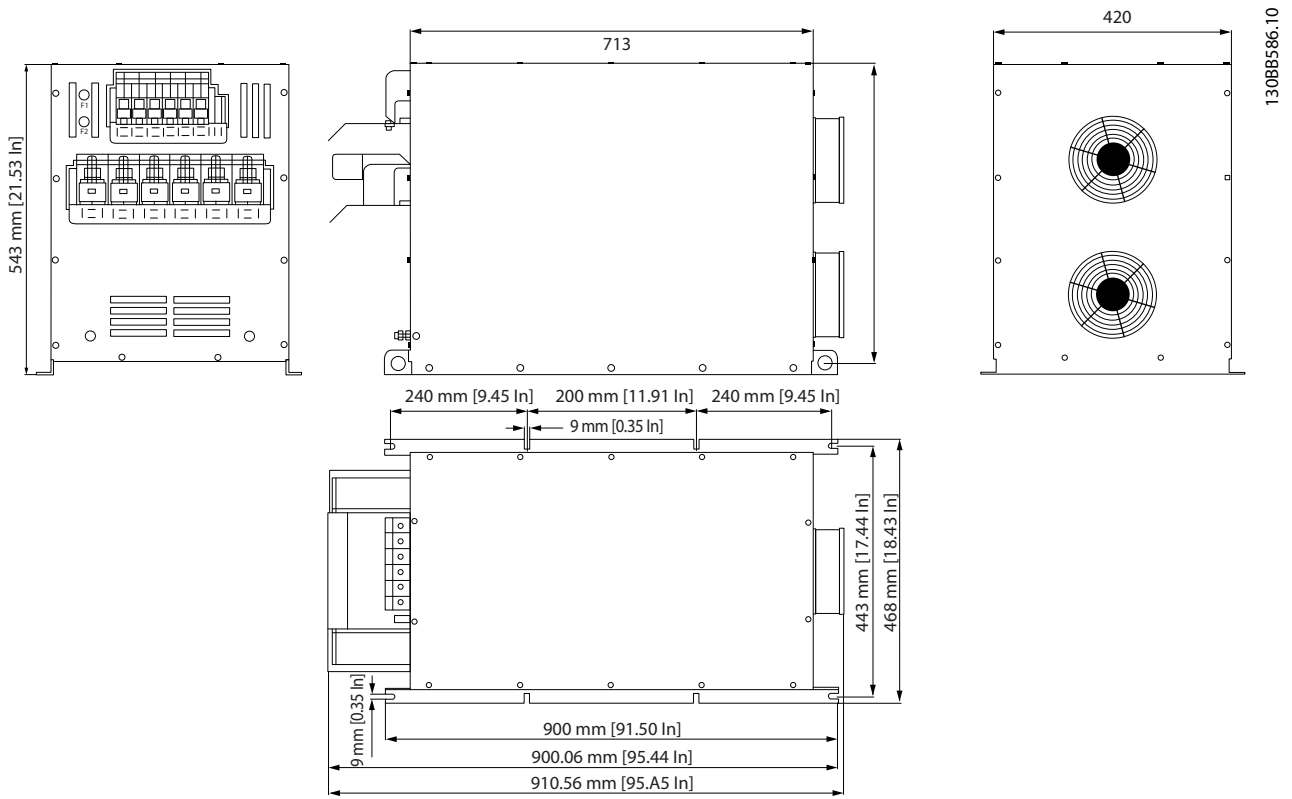

Illustration 6.13 X8 External Fan

6.3.2 IP00 Enclosures

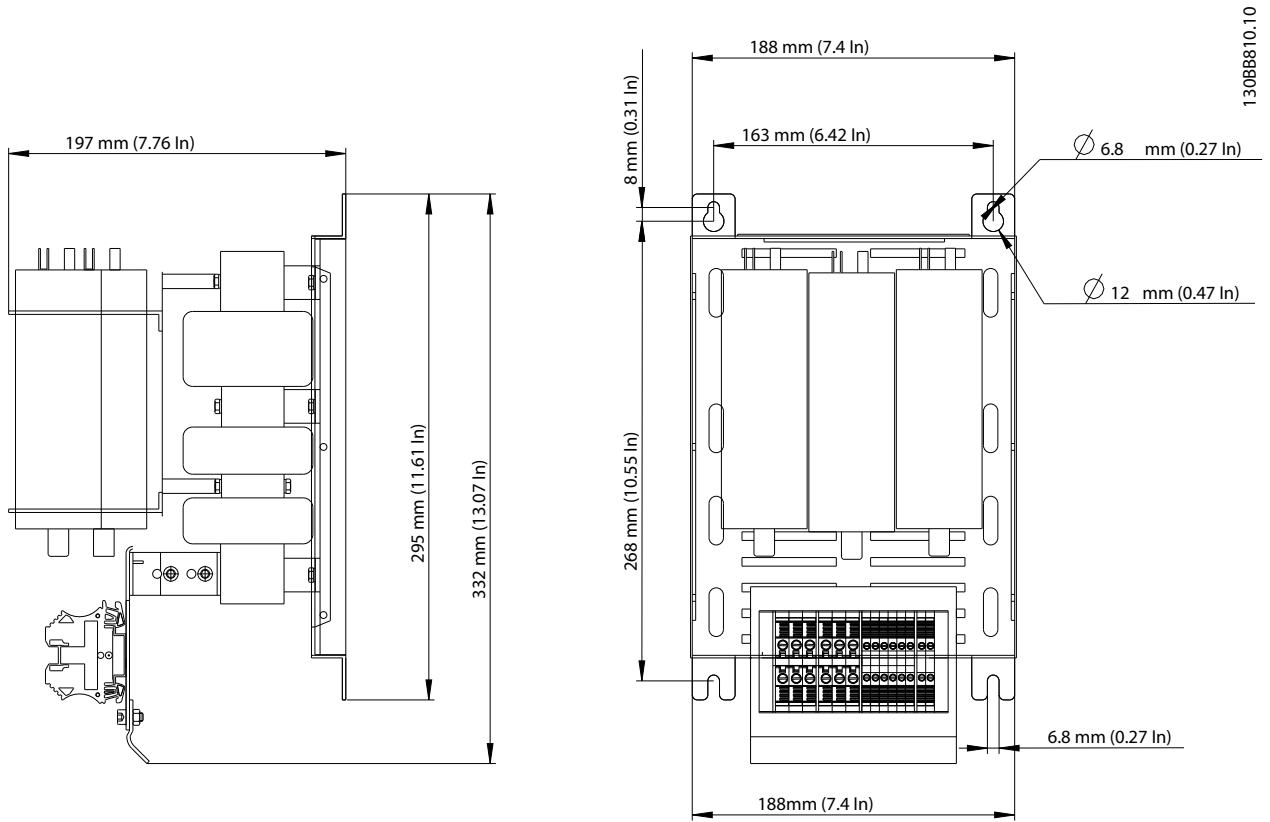

Illustration 6.14 X1



6

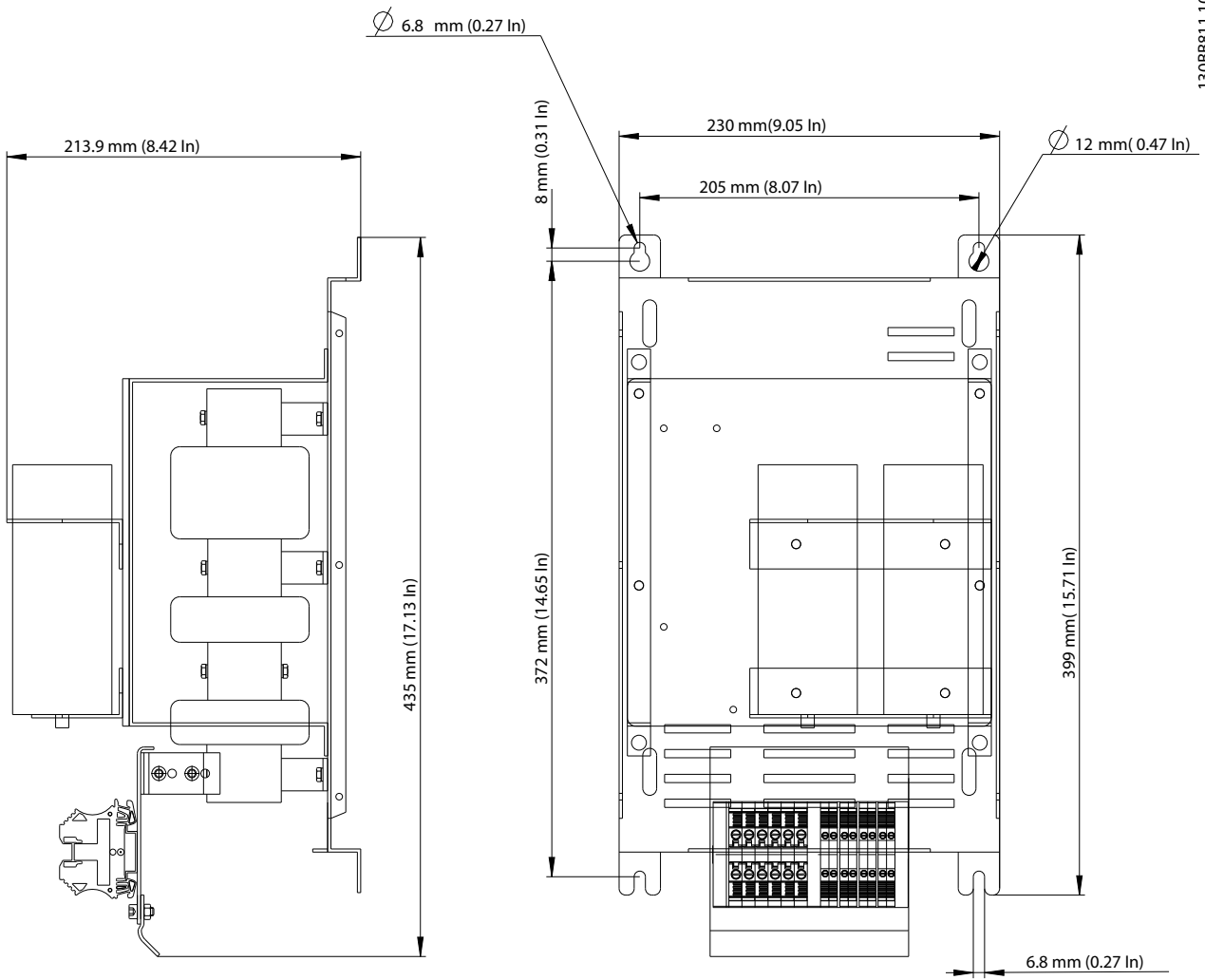

Illustration 6.15 X2

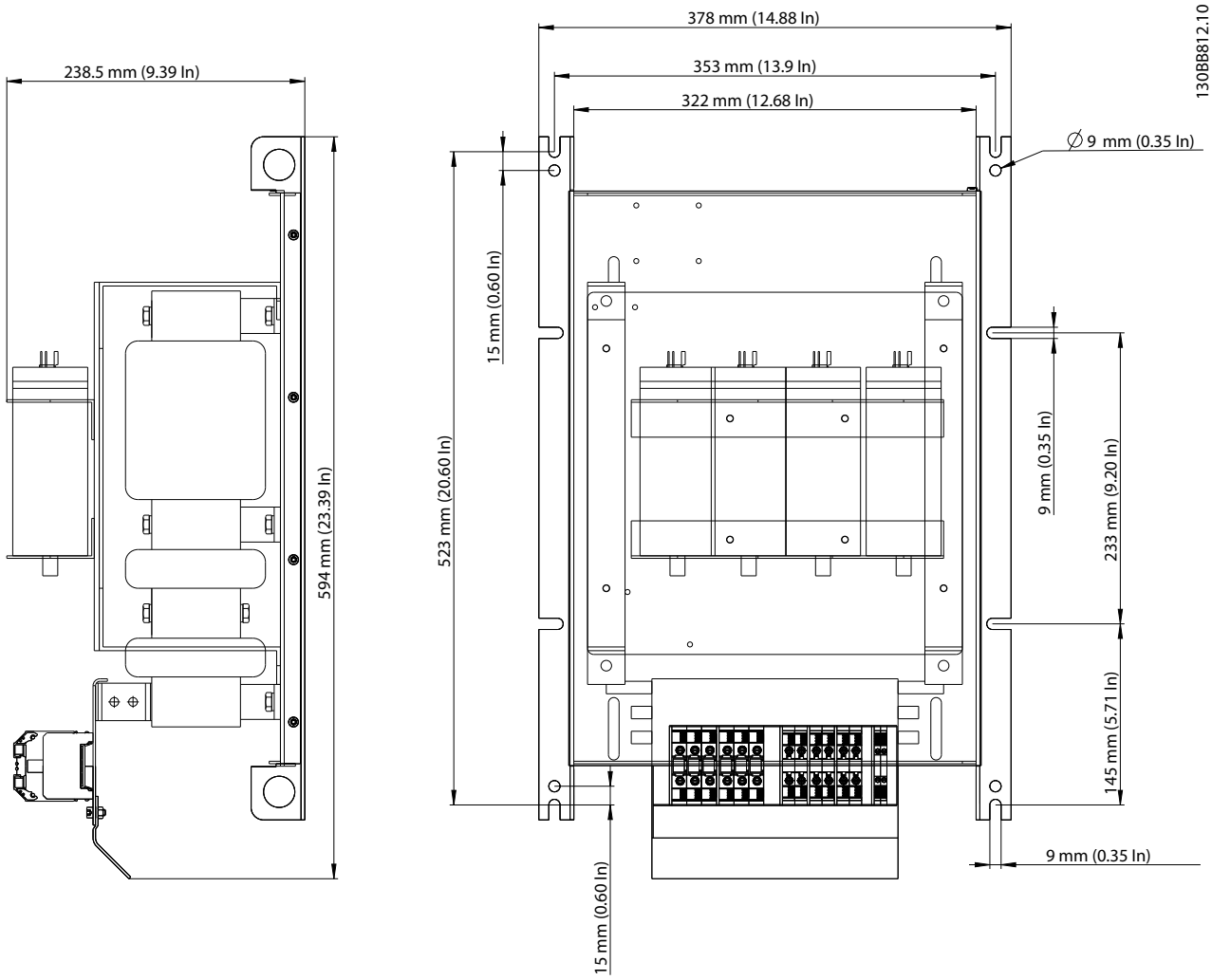

Illustration 6.16 X3

6

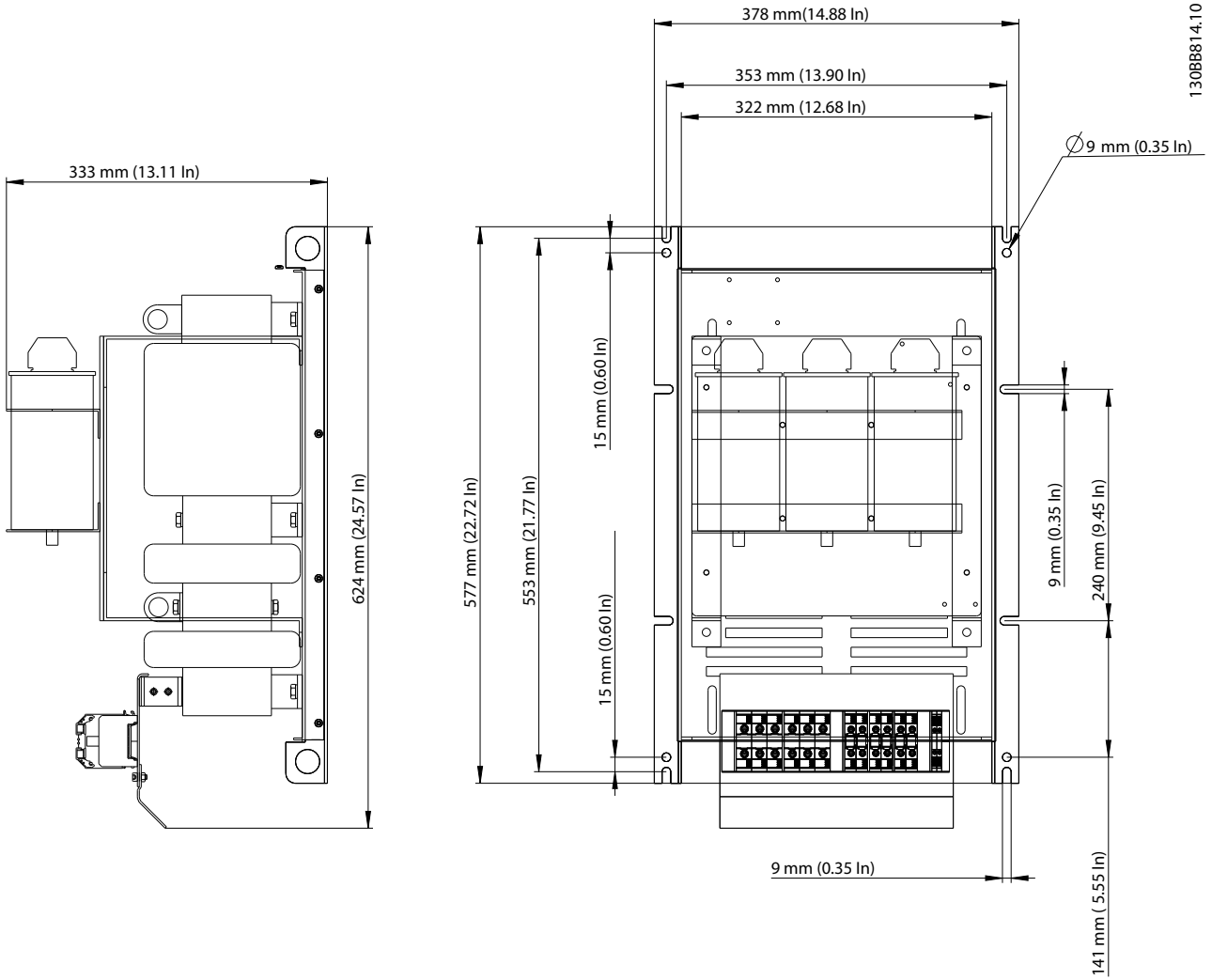

Illustration 6.17 X4

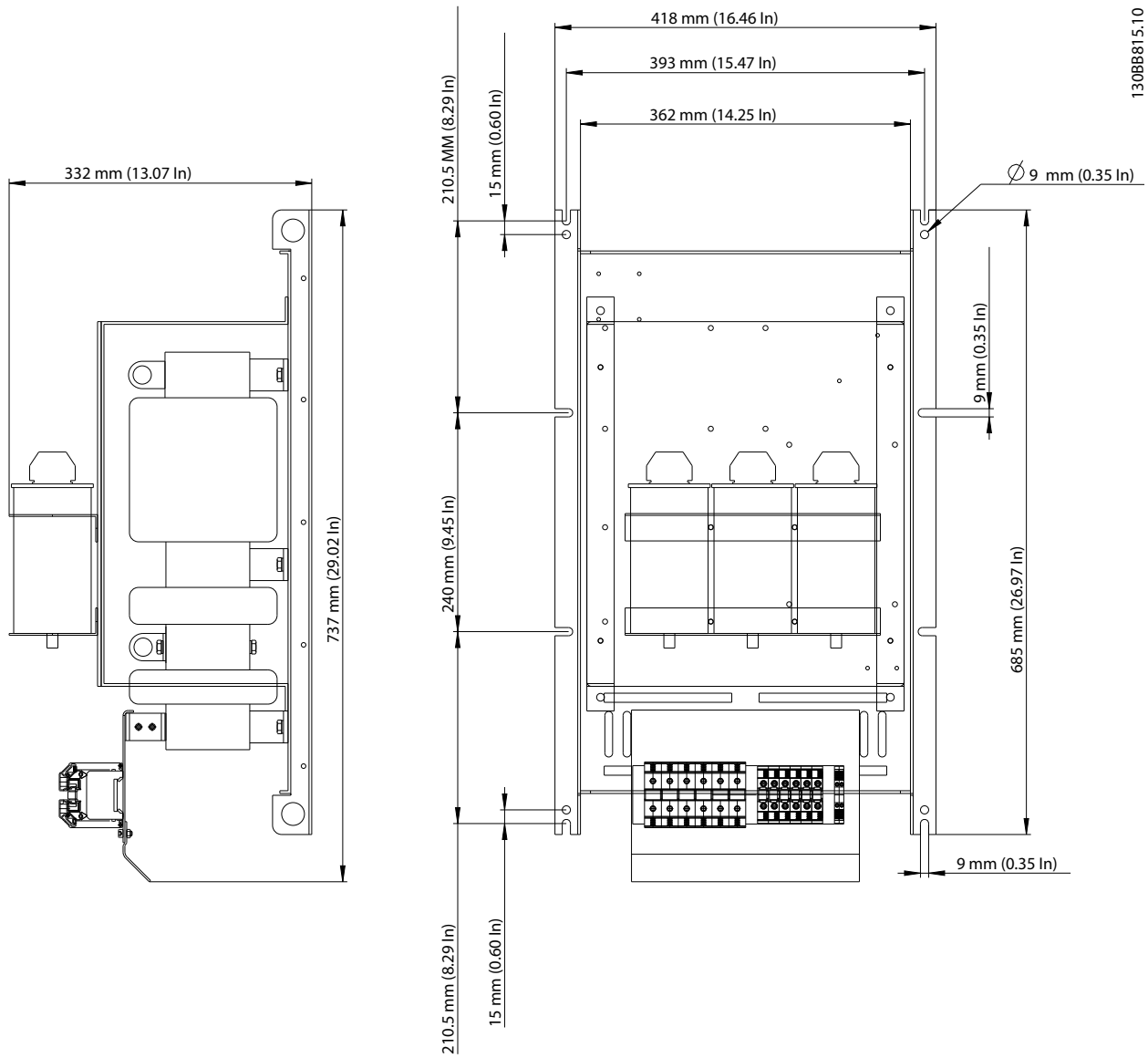

Illustration 6.18 X5

6

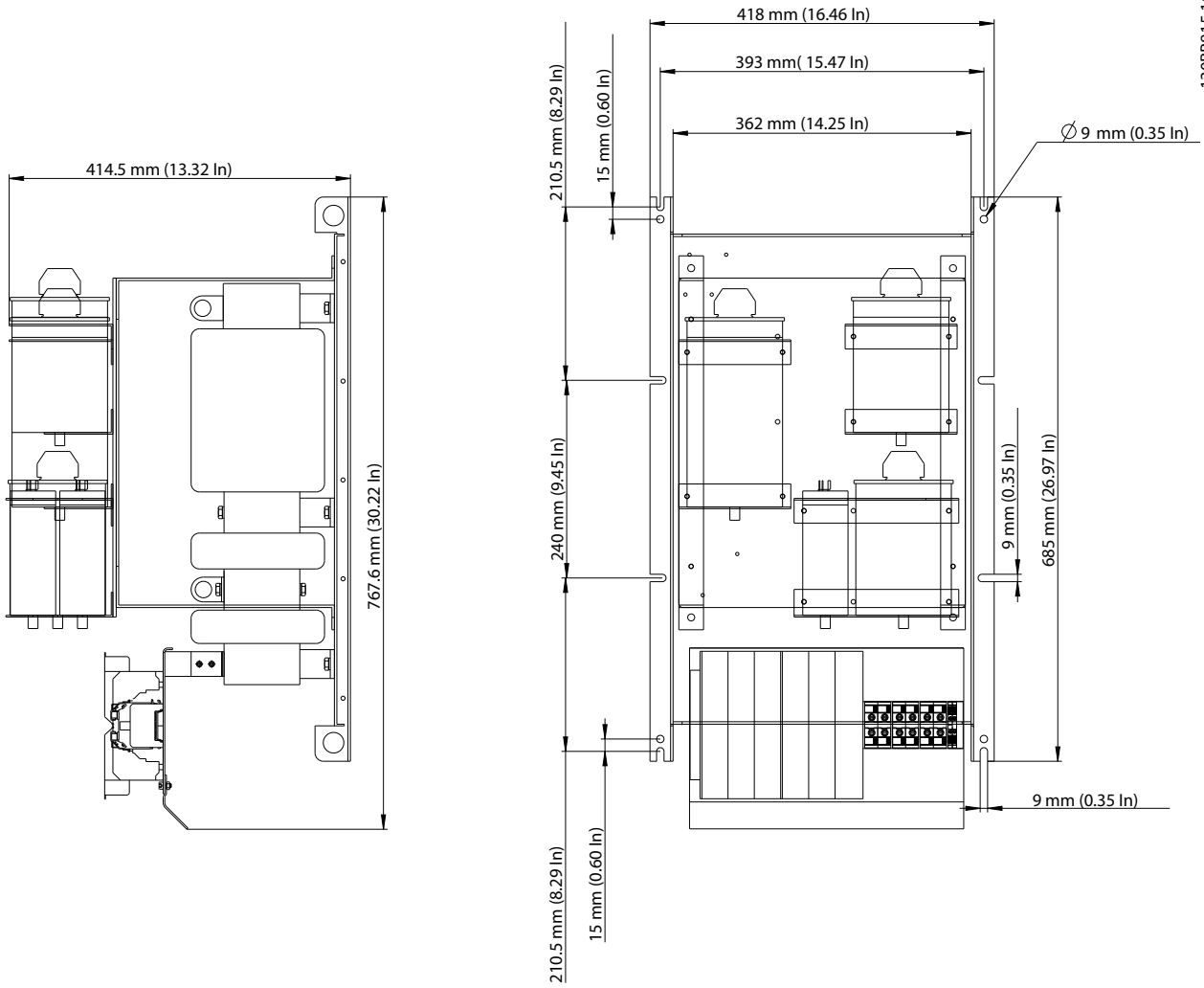
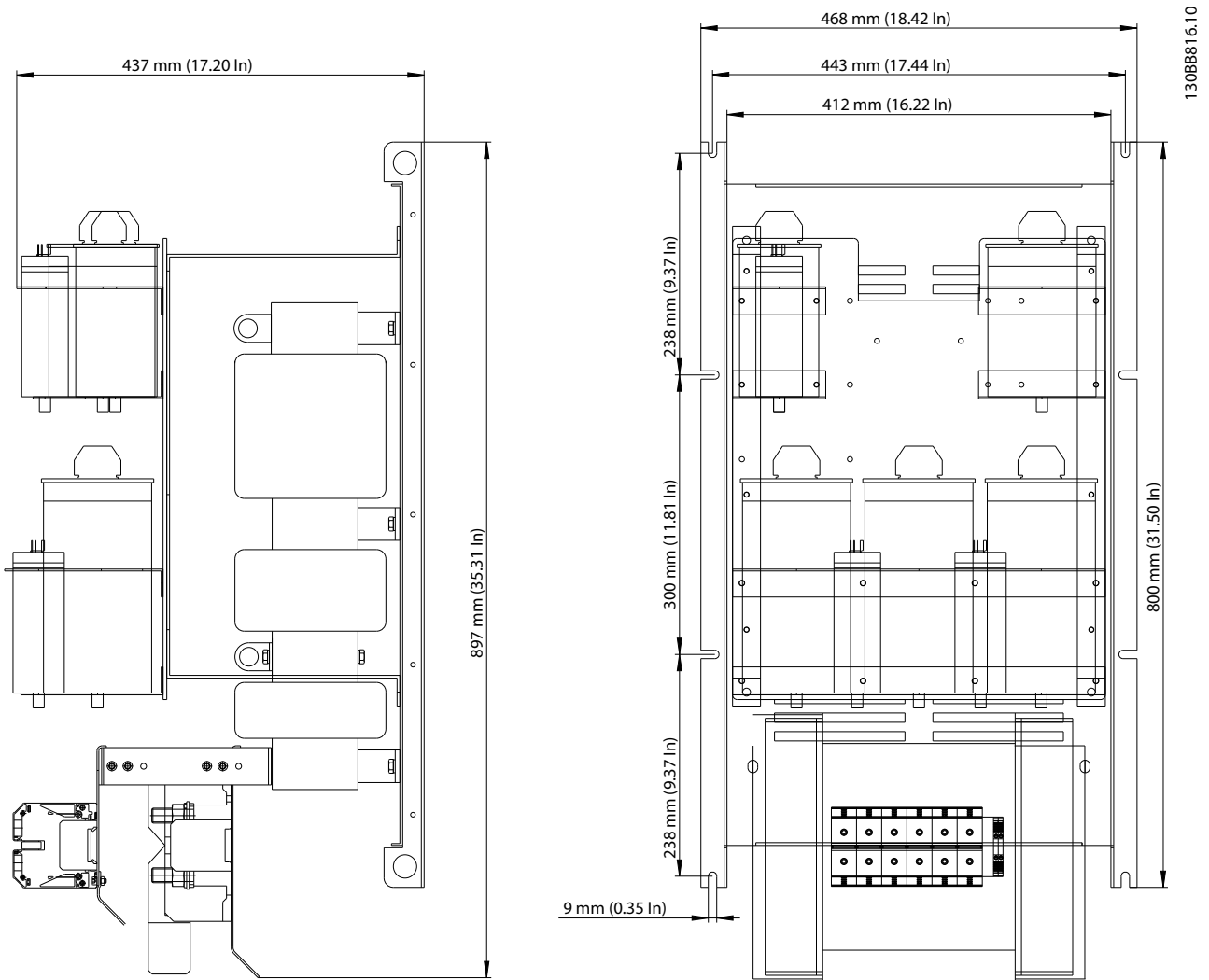

Illustration 6.19 X6



6

Illustration 6.20 X7

6

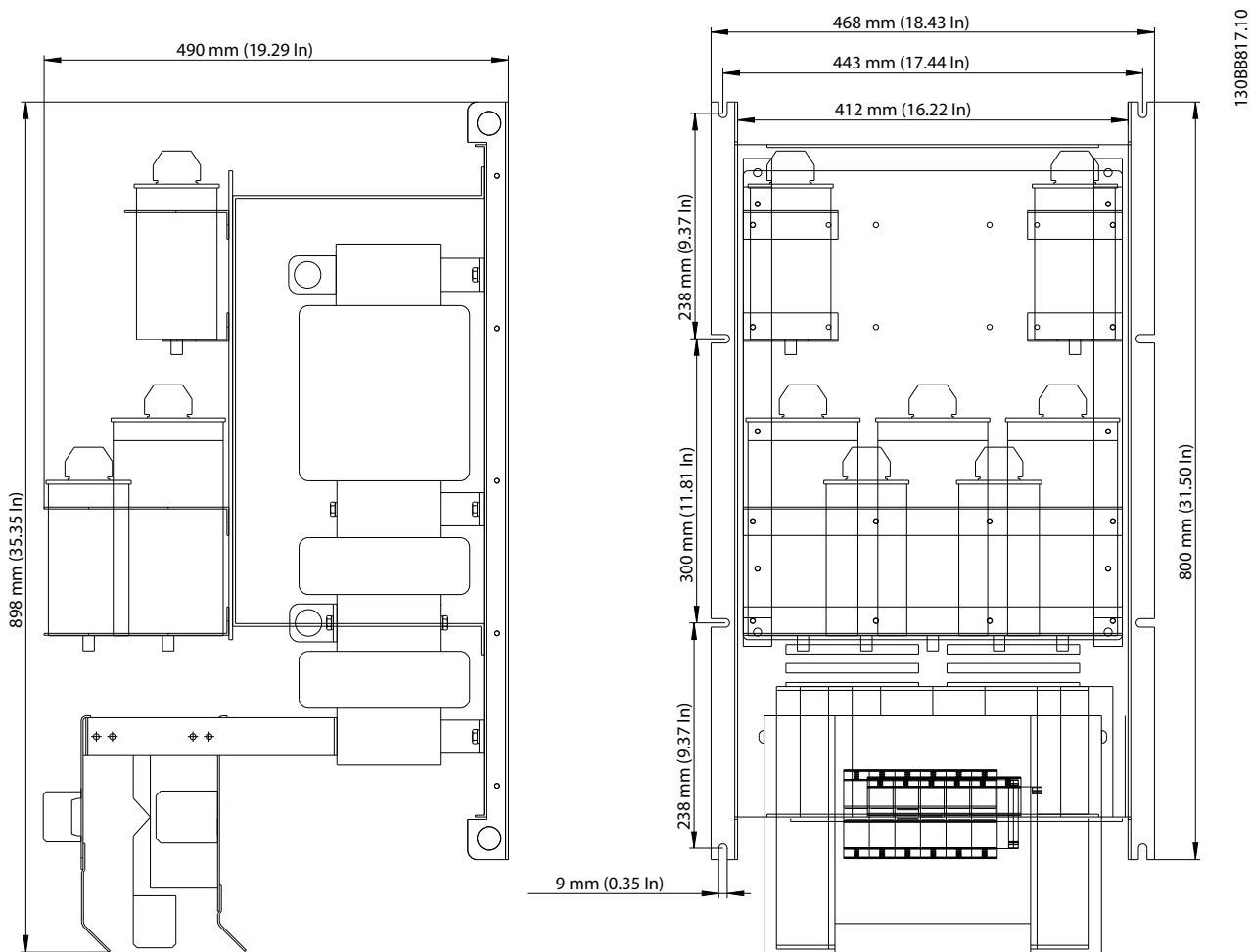

Illustration 6.21 X8

6.3.3 Physical Dimensions

Enclosure type	Dimensions in mm		
	A (height)	B (width)	C (depth)
X1	245	190	205
X2	350	230	248
X3	460	330	242
X4	490	330	333
X5	747	370	333
X6	778	370	400
X7	909	468	450
X8	911	468	550

6.3.4 IP00 Dimensions

Enclosure Type	Dimensions in mm		
	A (height)	B (width)	C (depth)
X1	332	188	197
X2	435	230	214
X3	594	378	239
X4	624	378	333
X5	737	418	332
X6	767	418	415
X7	897	468	437
X8	898	468	490

### 6.3.5 Weight

Current rating	AHF010 380 - 415V, 50Hz			AHF005 380 - 415V, 50Hz		
	Frame size	Weight IP20	Weight IP00	Frame size	Weight IP20	Weight IP00
	[A]	[kg]	[kg]		[kg]	[kg]
10	X1	12	8	X1	16	12
14	X1	13	9	X1	20	16
22	X2	22	17	X2	34	29
29	X2	25	5	X2	42	37
34	X3	36	6	X3	50	44
40	X3	40	7	X3	52	45
55	X3	42	7	X3	75	68
66	X4	52	7	X4	82	75
82	X4	56	9	X4	96	87
96	X5	62	10	X5	104	94
133	X5	74	10	X5	130	120
171	X6	85	74	X6	135	124
204	X6	105	94	X6	168	157
251	X7	123	106	X7	197	180
304	X7	136	120	X7	220	204
325	X7	142	126	X7	228	212
381	X7	163	147	X8	260	244
480	X8	205	186	X8	328	309

Current rating	AHF010 440 - 480V, 60Hz			AHF005 440 - 480V, 60Hz		
	Frame size	Weight IP20	Weight IP00	Frame size	Weight IP20	Weight IP00
	[A]	[kg]	[kg]		[kg]	[kg]
10	X1	12	8	X1	16	12
14	X1	13	9	X1	20	16
19	X2	22	17	X2	34	29
25	X2	25	20	X2	42	37
31	X3	36	30	X3	50	44
36	X3	40	33	X3	52	45
48	X3	42	35	X3	75	68
60	X4	52	45	X4	82	75
73	X4	56	47	X4	96	87
95	X5	62	52	X5	104	94
118	X5	74	64	X5	130	120
154	X6	85	74	X6	135	124
183	X6	105	94	X6	168	157
231	X7	123	106	X7	197	180
291	X7	136	120	X7	220	204
355	X7	163	126	X7	260	212
380	X7	178	147	X8	295	244
436	X8	205	186	X8	328	309

Current rating	AHF010 380 - 415V, 60Hz			AHF005 380 - 415V, 60Hz		
	Frame size	Weight IP20	Weight IP00	Frame size	Weight IP20	Weight IP00
	[A]	[kg]	[kg]		[kg]	[kg]
10	X1	12	8	X1	16	12
14	X1	13	9	X1	20	16
22	X2	22	17	X2	34	29
29	X2	25	20	X2	42	37
34	X3	36	30	X3	50	44
40	X3	40	33	X3	52	45
55	X3	42	35	X3	75	68
66	X4	52	45	X4	82	75
82	X4	56	47	X4	96	87
96	X5	62	52	X5	104	94
133	X5	74	64	X5	130	120
171	X6	85	74	X6	135	124
204	X6	105	94	X6	168	157
251	X7	123	106	X7	197	180
304	X7	136	120	X7	220	204
325	X7	142	126	X7	228	212
381	X7	163	147	X8	260	244
480	X8	205	186	X8	328	309

Current rating	500-690V, 50Hz			600V, 60Hz		
	Frame size	Weight IP00	Weight IP20	Frame size	Weight IP00	Weight IP20
	[A]	[kg]	[kg]		[kg]	[kg]
15	X3	25	31	X3	42	31
20	X3	36	42	X3	50	42
24	X3	40	46	X3	52	46
29	X4	42	49	X4	75	49
36	X4	52	59	X4	82	59
50	X5	56	66	X5	96	66
58	X5	62	72	X5	104	72
77	X6	74	85	X6	130	85
87	X6	85	96	X6	135	96
109	X6	105	116	X6	168	116
128	X6	123	134	X6	197	134
155	X7	136	152	X7	220	152
197	X7	142	158	X7	228	158
240	X8	163	182	X8	260	182
296	X8	205	224	X8	297	224
366	X8	228	244			
395	X8	260	276			



## 7 How to Programme the Frequency Converter

### 7.1.1 DC-link Compensation Disabling

The FC series include a feature which ensures that the output voltage is independent of any voltage fluctuation in the DC link, e.g. caused by fast fluctuation in the mains supply voltage. In some cases this very dynamic compensation can produce resonances in the DC link and should then be disabled. Typical cases are where AHF005/010 is used on supply grids with high short circuit ratio. Fluctuations can often be recognized by increased acoustical noise and in extreme cases by unintended tripping. To prevent resonances in the DC-link, it is recommended to disable the dynamic DC-link compensation by setting *14-51 DC Link Compensation* to off.

7

14-51 DC Link Compensation		
Option:	Function:	
[0]	Off	Disables DC Link Compensation.
[1] *	On	Enables DC Link Compensation.

**Index**

<b>A</b>		<b>M</b>	
Abbreviations.....	4	MCT 31.....	12
Active Filters.....	14	<b>N</b>	
Apparent Power.....	7	Nominal Motor Current.....	15
<b>B</b>		Non-linear Loads.....	8
Background Distortion.....	12	<b>O</b>	
<b>C</b>		Over Temperature Protection.....	32
Capacitive Current.....	14	<b>P</b>	
Capacitor Disconnect.....	14	Partial	
CE Conformity And Labelling.....	4	Load.....	12
<b>D</b>		Weighted Harmonic Distortion.....	9
Derating.....	27	Point Of Common Coupling.....	9
Displacement		Power Factor.....	7, 14, 33
Angle.....	7	<b>R</b>	
Power Factor.....	8, 9	Reactive Power.....	7
<b>E</b>		Real Power.....	7
Efficiency.....	27	<b>S</b>	
<b>F</b>		Screening.....	29
Fundamental Frequency.....	8	Short Circuit Ratio.....	9
<b>G</b>		<b>T</b>	
G5/4.....	10	The Low-voltage Directive (73/23/EEC).....	4
General Warning.....	4	Total	
Generator.....	14	Current Harmonic Distortion.....	12
Grid Unbalance.....	12	Demand Distortion.....	9
Grounding.....	29	Harmonic Distortion (THD).....	8
<b>H</b>		True Power Factor.....	8, 13
Harmonic		<b>I</b>	
Calculation Software.....	12	IEC/EN	
Mitigation Standards.....	10	61000-3-2.....	10
High-voltage Warning.....	4	61000-3-4.....	10
<b>I</b>		IEEE 519.....	10
IEC/EN		IP21/NEMA1 Enclosure Kits.....	26
61000-3-2.....	10	<b>L</b>	
61000-3-4.....	10	Leading Current.....	33
IEEE 519.....	10		
IP21/NEMA1 Enclosure Kits.....	26		
<b>L</b>			
Leading Current.....	33		



[www.danfoss.com/drives](http://www.danfoss.com/drives)

---

Danfoss can accept no responsibility for possible errors in catalogues, brochures and other printed material. Danfoss reserves the right to alter its products without notice. This also applies to products already on order provided that such alterations can be made without subsequential changes being necessary in specifications already agreed. All trademarks in this material are property of the respective companies. Danfoss and the Danfoss logotype are trademarks of Danfoss A/S. All rights reserved.

---

